

902 MHz Presentations

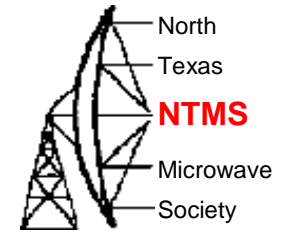

- *Getting Started on 902 MHz at W5LUA*
- *Paralleling high power 900 MHz amplifiers by W5LUA*
- *Review of the W1GHz 902 MHz transverter by N5AC*
- *902 MHz Transverter at KA5BOU*
- *902 MHz Transverter at NM5M*
- *902 MHz Transverter at WB5ZDP*
- *902 MHz W0PW Dual Dipole Feed by WW2R*
- *902 MHz EME at WA8RJF EN91*
- *DEMI 902 MHz Transverter demo by W5SXD*

The 33 cm Band

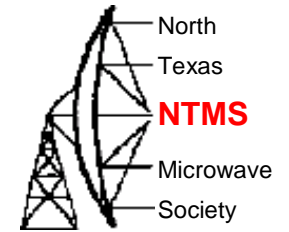

- 902 to 928 MHz
- Weak signal work at 902.0 to 902.5 MHz and at 903 to 903.5 MHz east of the Mississippi River
- Weak signal calling frequency for us is 902.1 MHz
- Shared with Part 15 and ISM on a non-interfering basis - Bull
- No commercial store bought radios available for SSB and CW
- Build or buy a transverter to go with your multimode 2M radio or HF transceiver
- Antennas – both loop yagis and standard yagi design available including some pretty simple antennas by Kent WA5VJB

WB5LUA 902 MHz Transverter

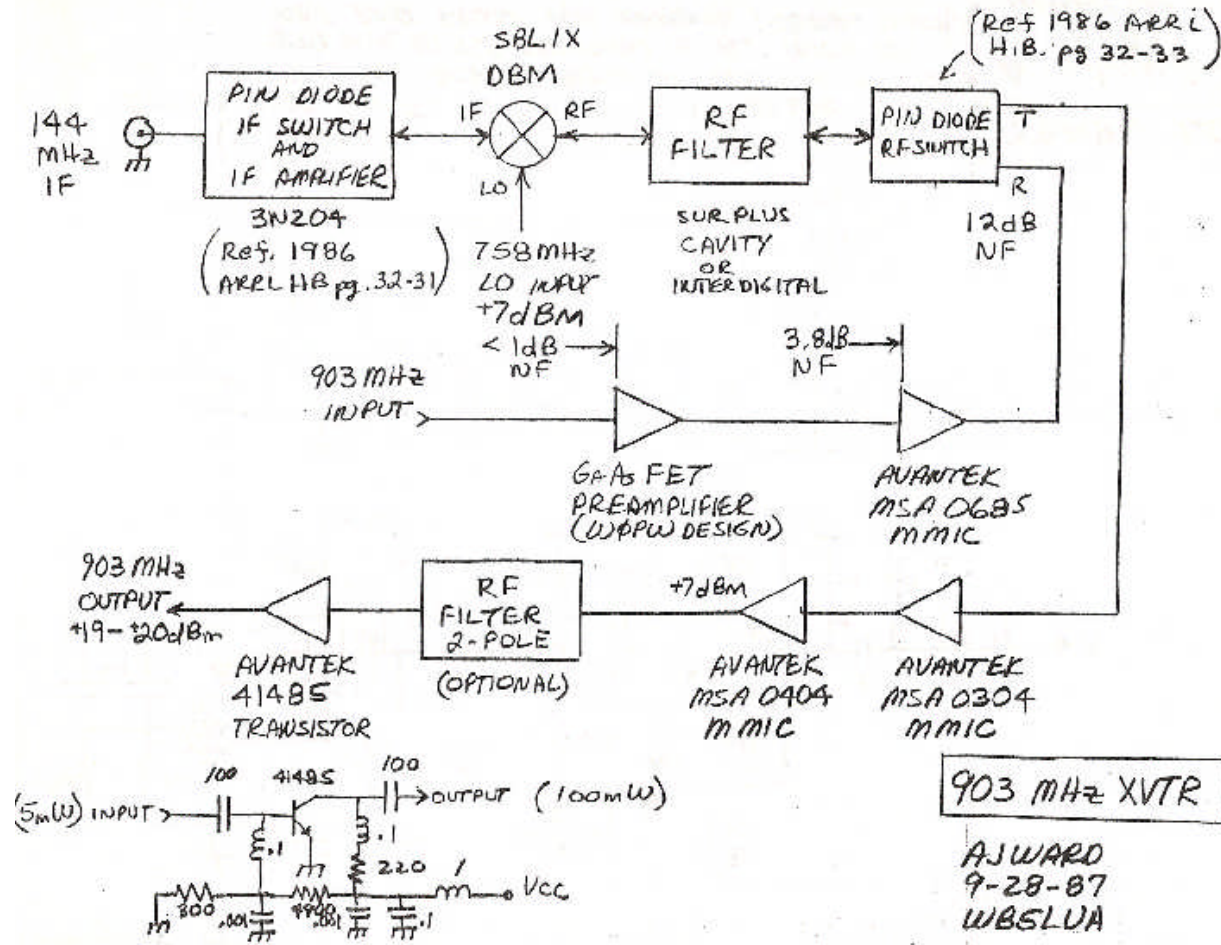
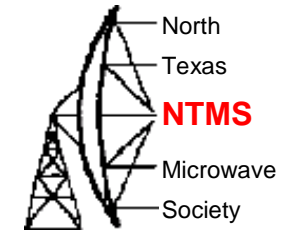

758 MHz LO

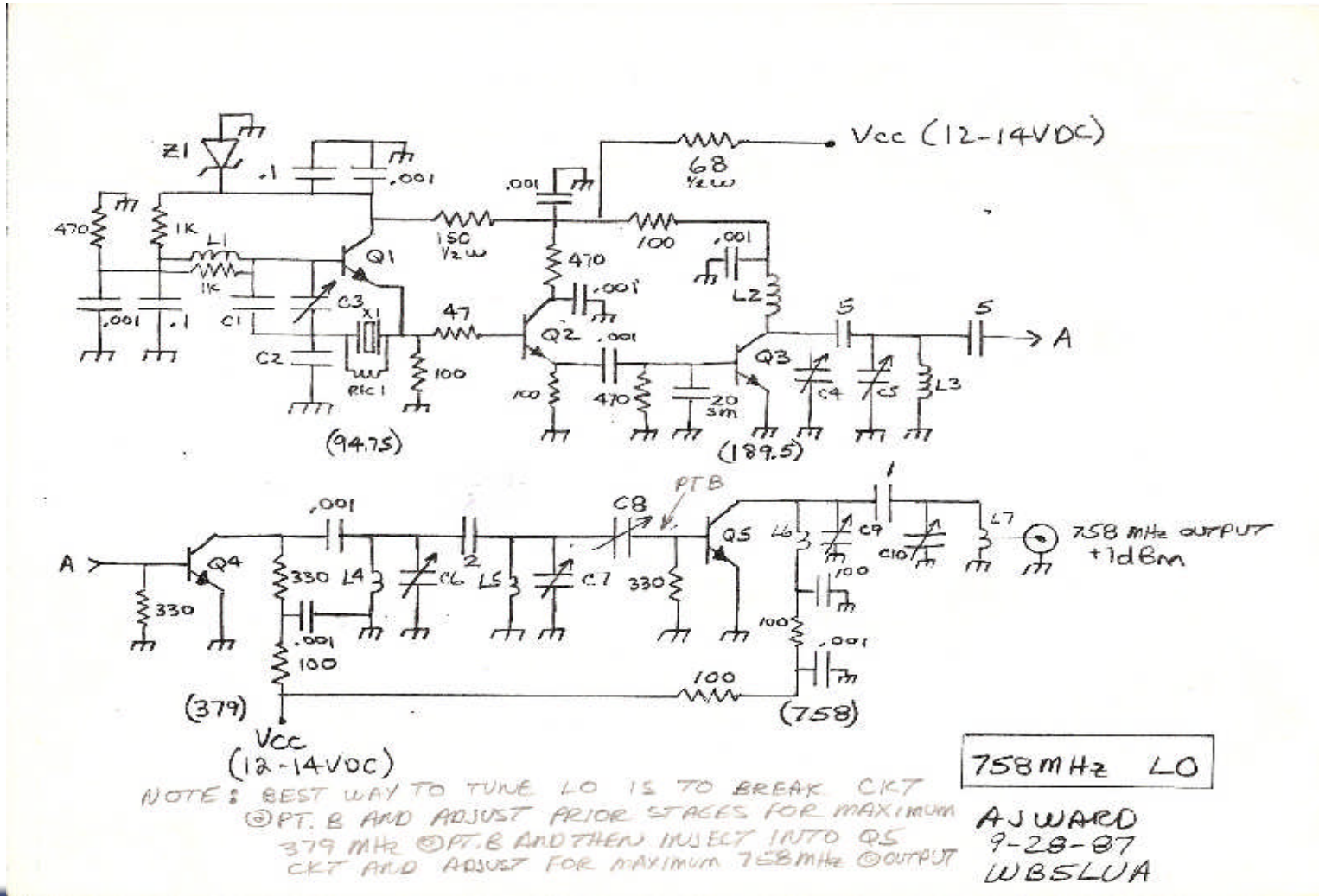
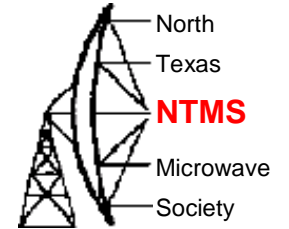

758 MHz LO Parts List

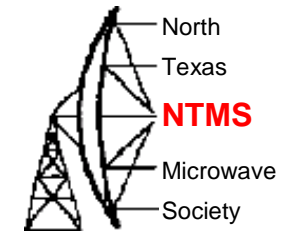

Z1	1N751 5VOLT ZENER DIODE
Q1-Q3	MRF904
Q4-Q5	MRF901
X1	94.75 MHz CRYSTAL (HA-5)
RFC1	.38 uH RF CHOKE
L1	7 TURNS #24, .25" I.D., CLOSE SPACED, WOUND ON
L2, L3	3 TURNS #14, .5" LONG
L4, L5	1 TURN #14, .25" I.D.
L6	WIRE #24 Gauge AS SHOWN IN VIEW A
L7	WIRE #24 Gauge AS SHOWN IN VIEW B
C1	10pF N750 CAP
C2	33pF N750 CAP
C3	3-18pF CERAMIC VARIABLE
C4-C10	.8-10pF PISTON VARIABLE

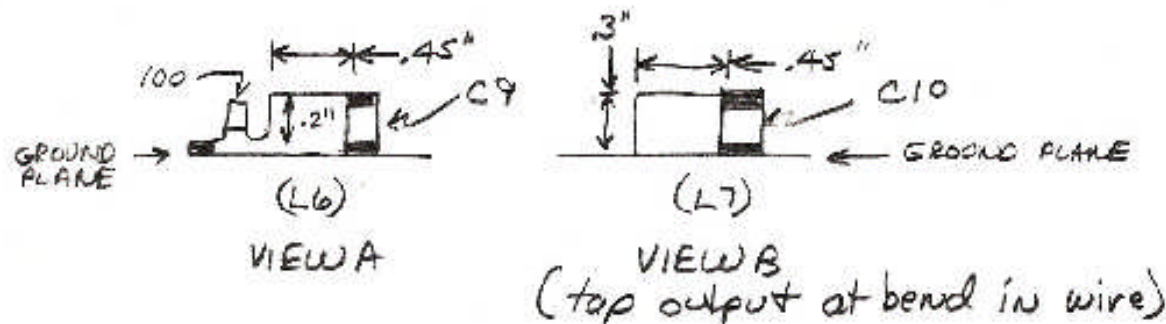

WB5LUA 902 MHz Transverter

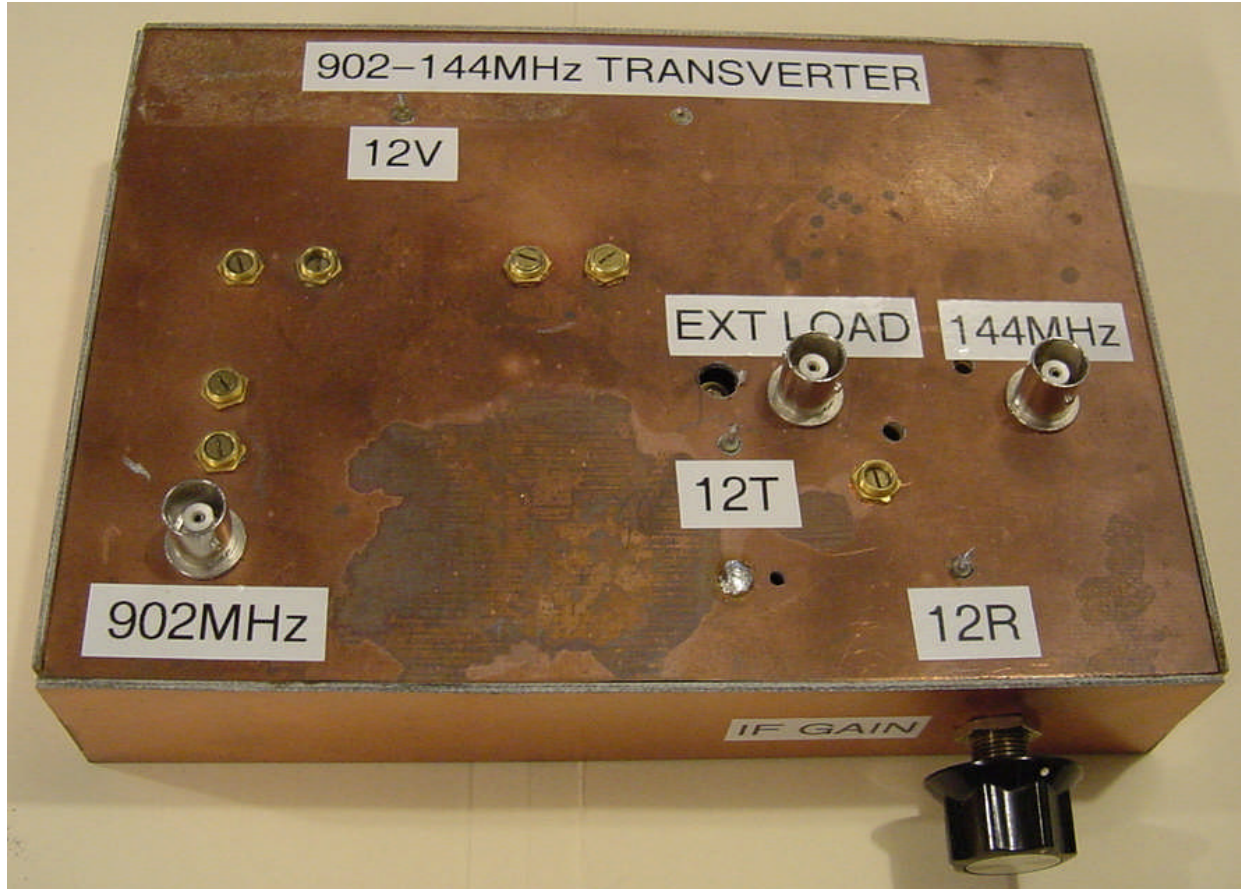
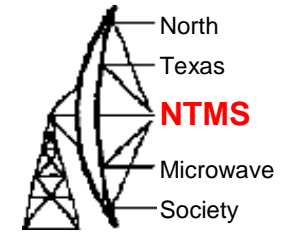

Built 1987

WB5LUA 902 MHz Transverter

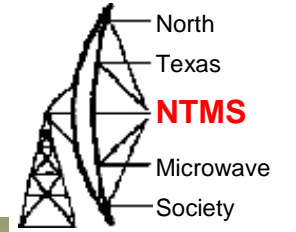

Band Pass Filters for 902 MHz

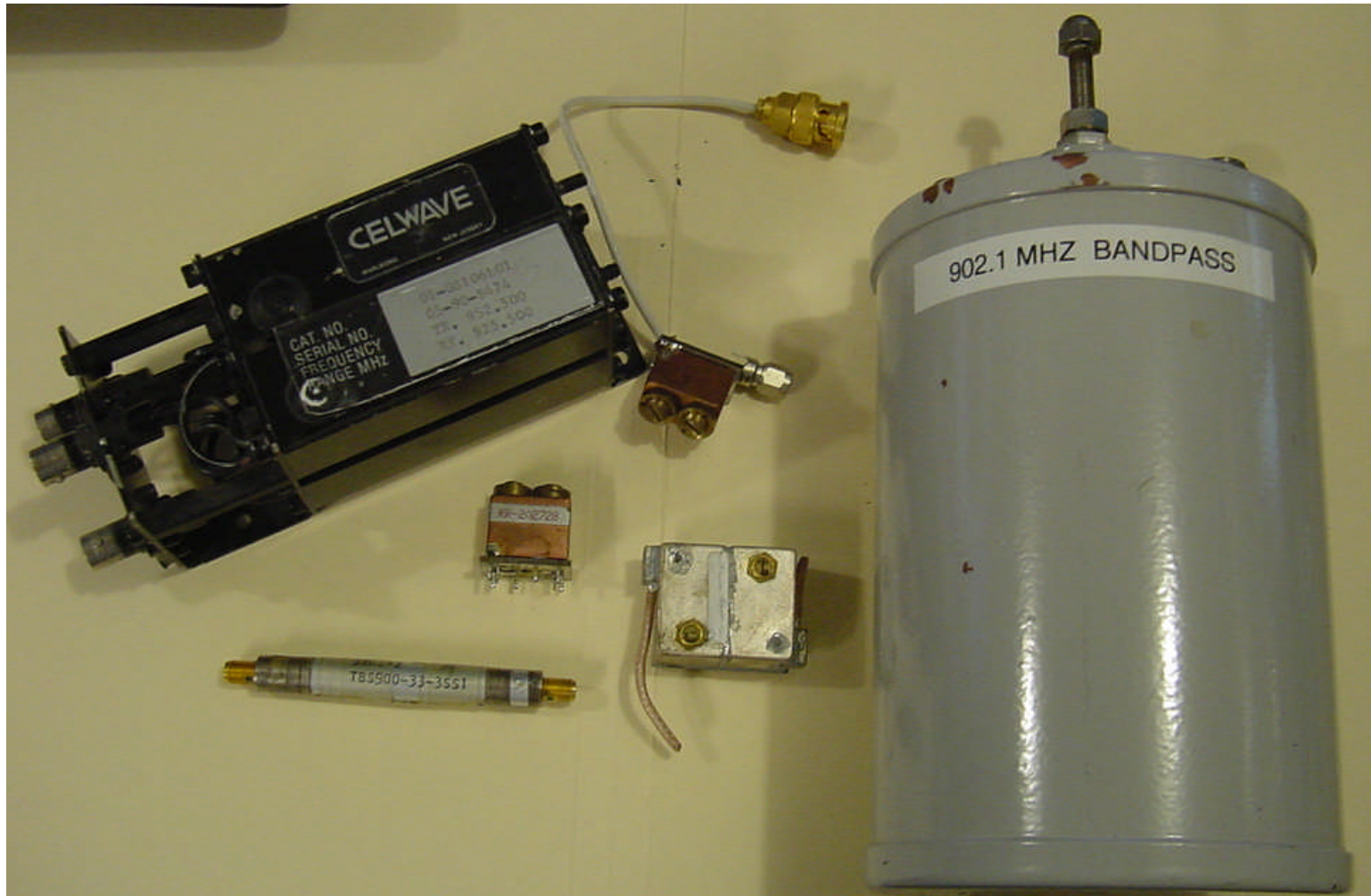

Components for 902 MHz



N5QGH 902 MHz Transverter using old KK7B no tune transverter Approach

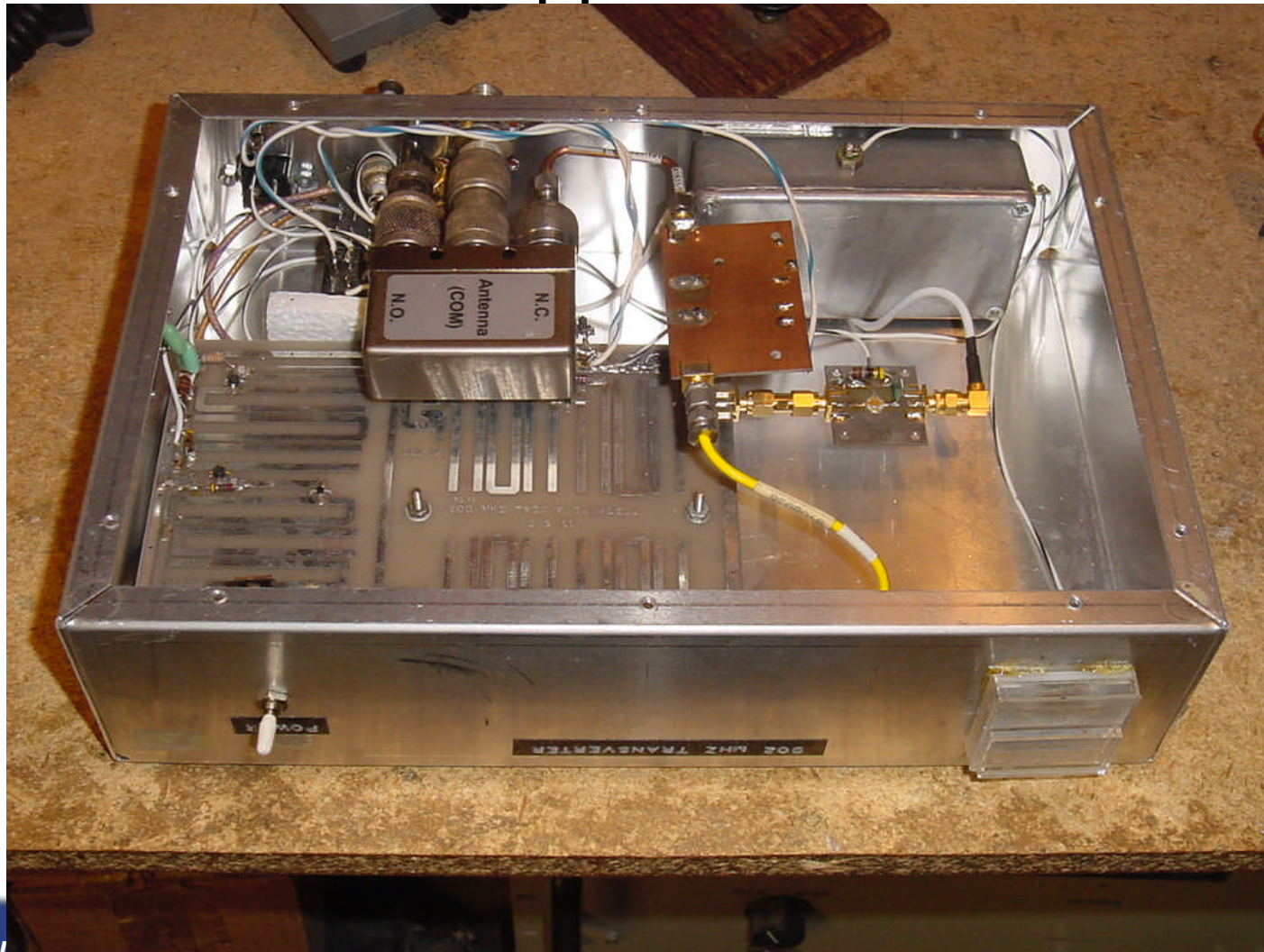
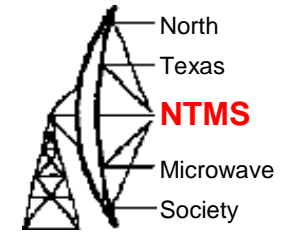

W5LUA 902 MHz ATF-36077 LNA

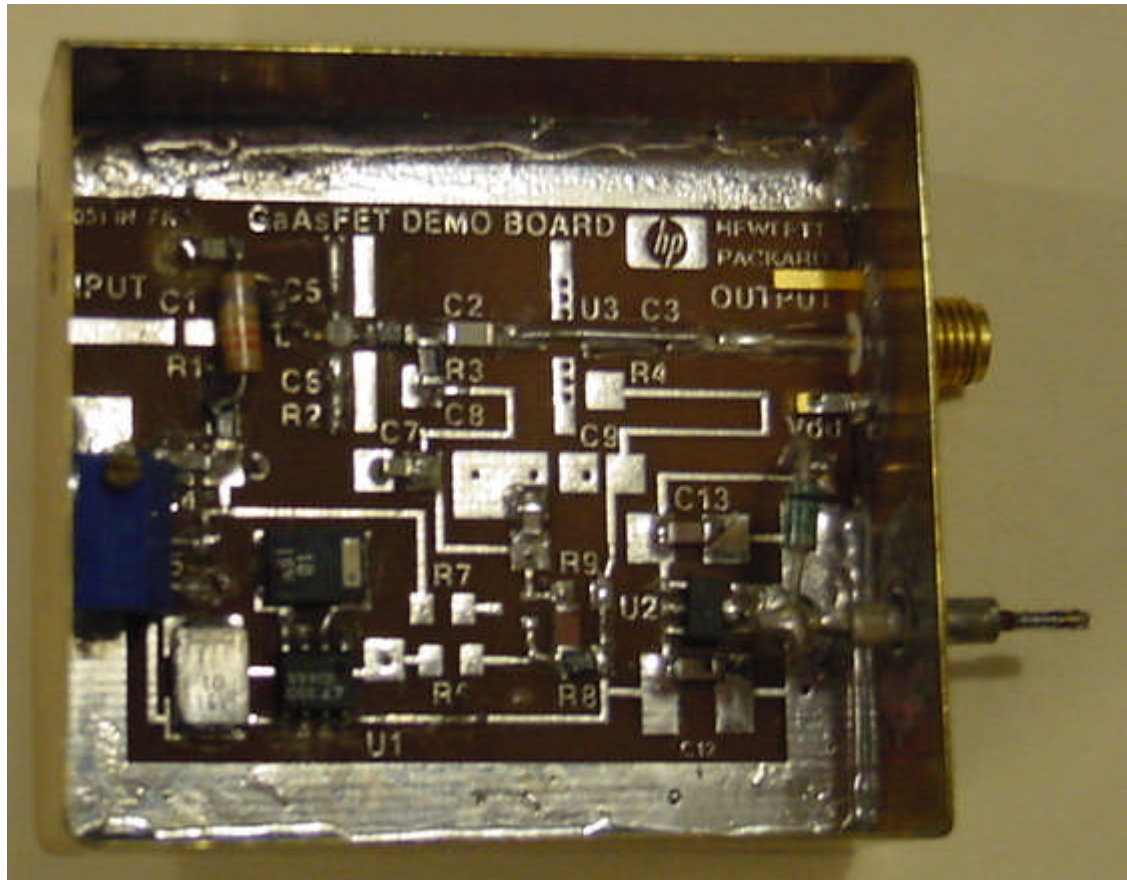
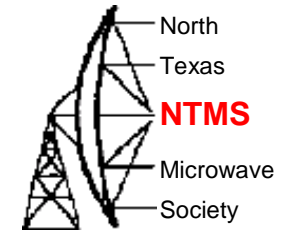

Reference Avago
Ap Note 1128

WW2R 902 MHz Transverter

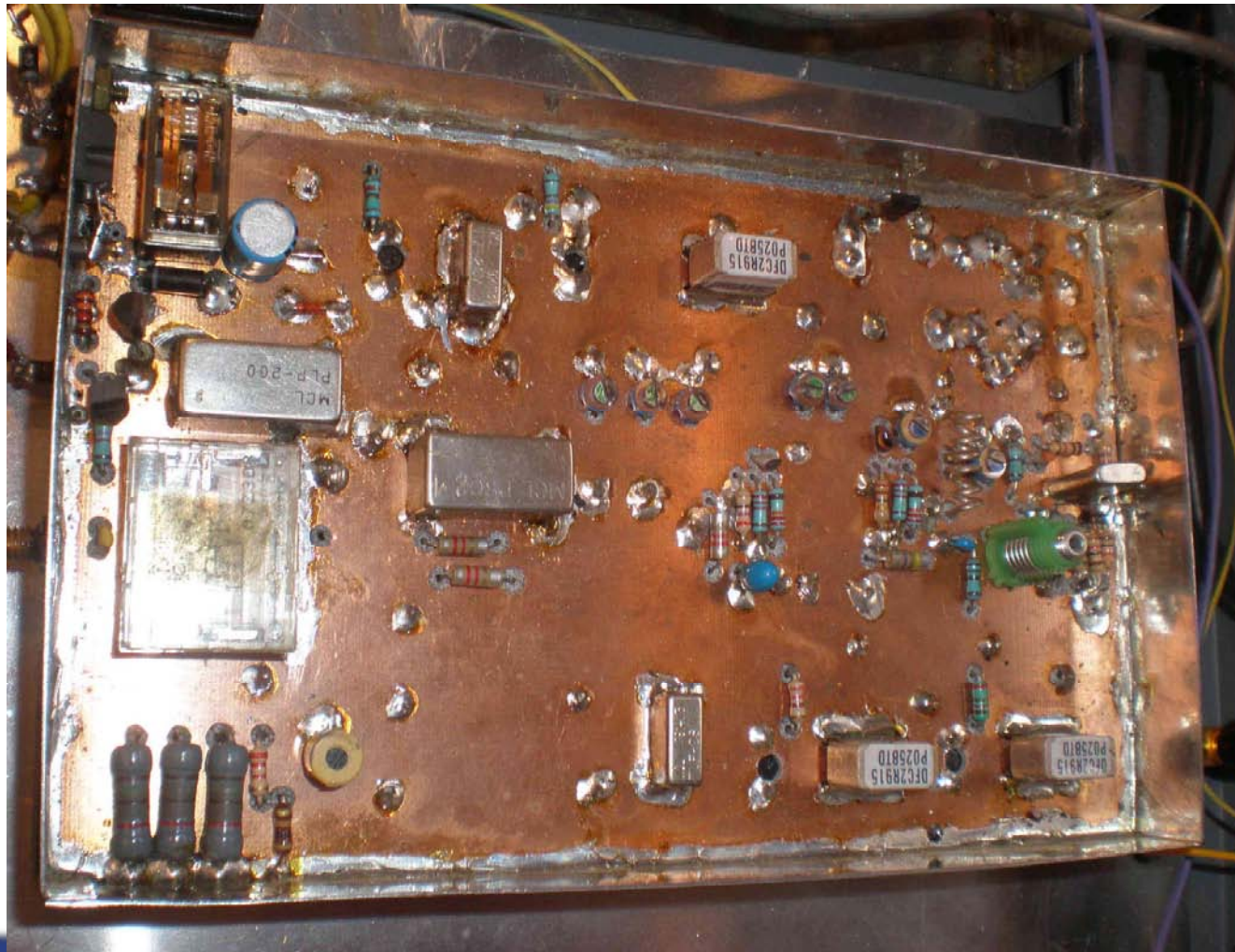
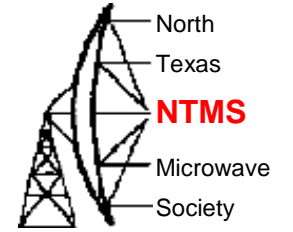

902 MHz PA Module

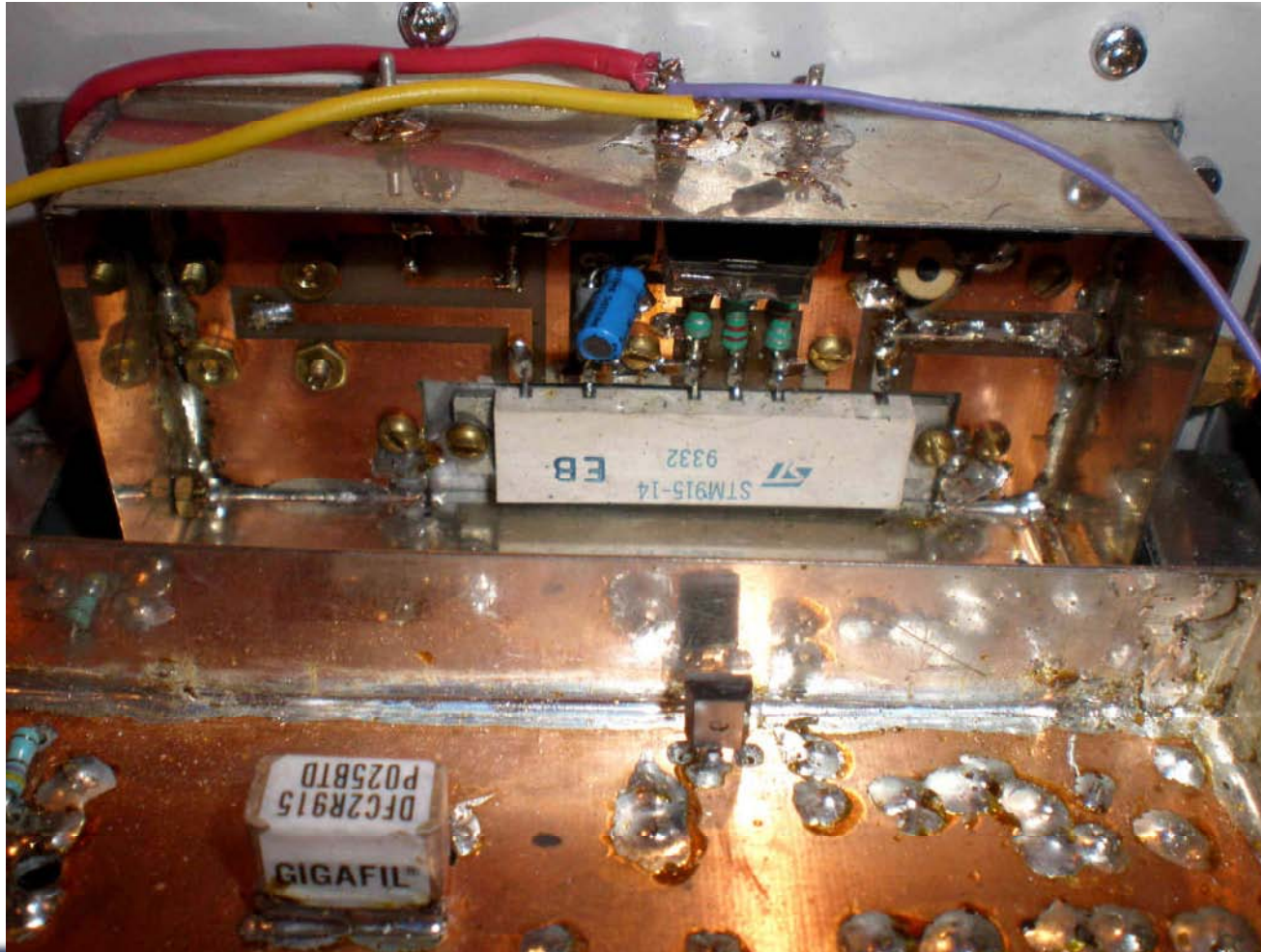

DEMI 902 MHz Transverter

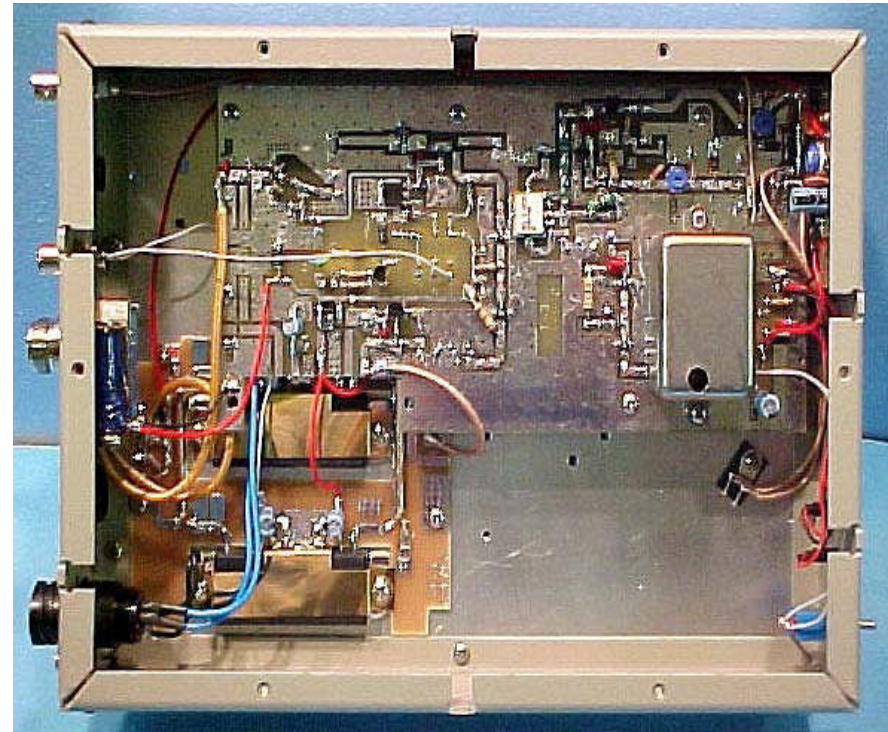
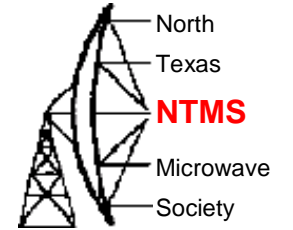

DEMI Demo by W5SXD

NM5M's 902 MHz XVTR

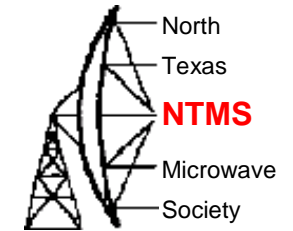

902 AMMO CAN TRANSVERTER

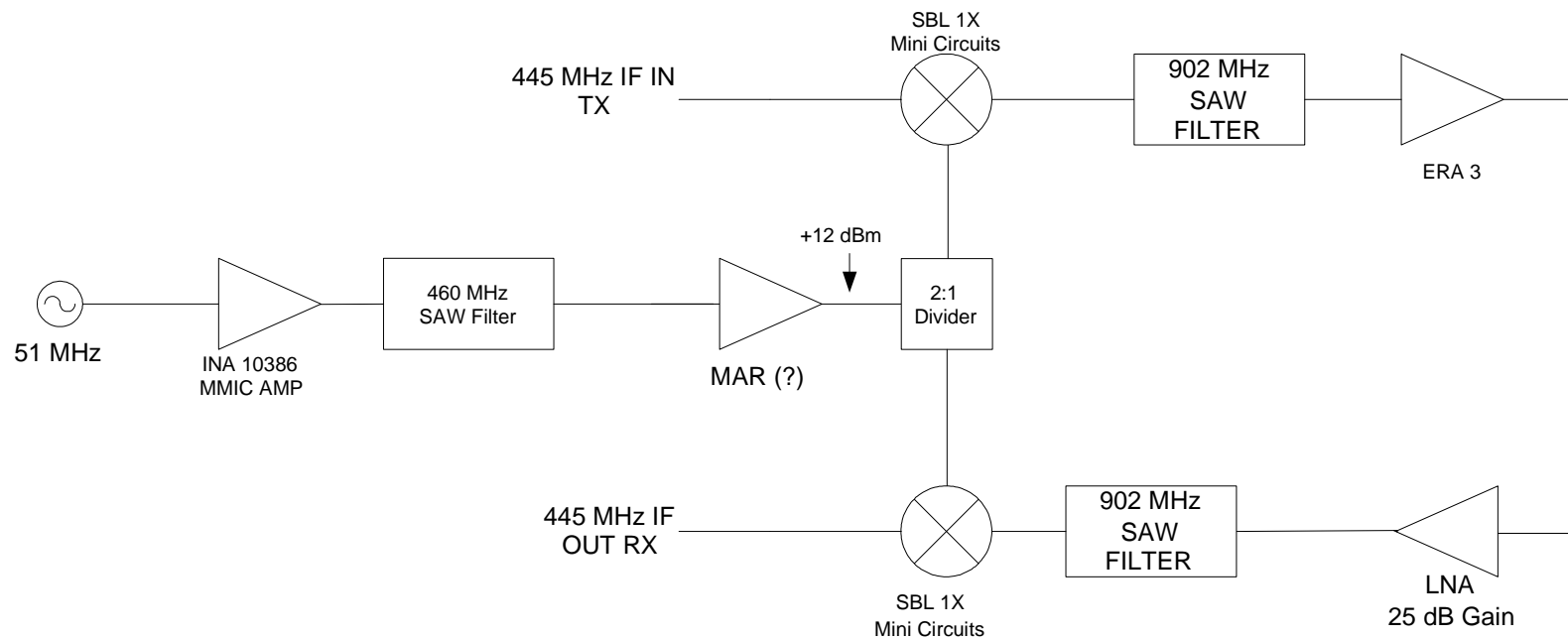

NM5M's 902 MHz XVTR

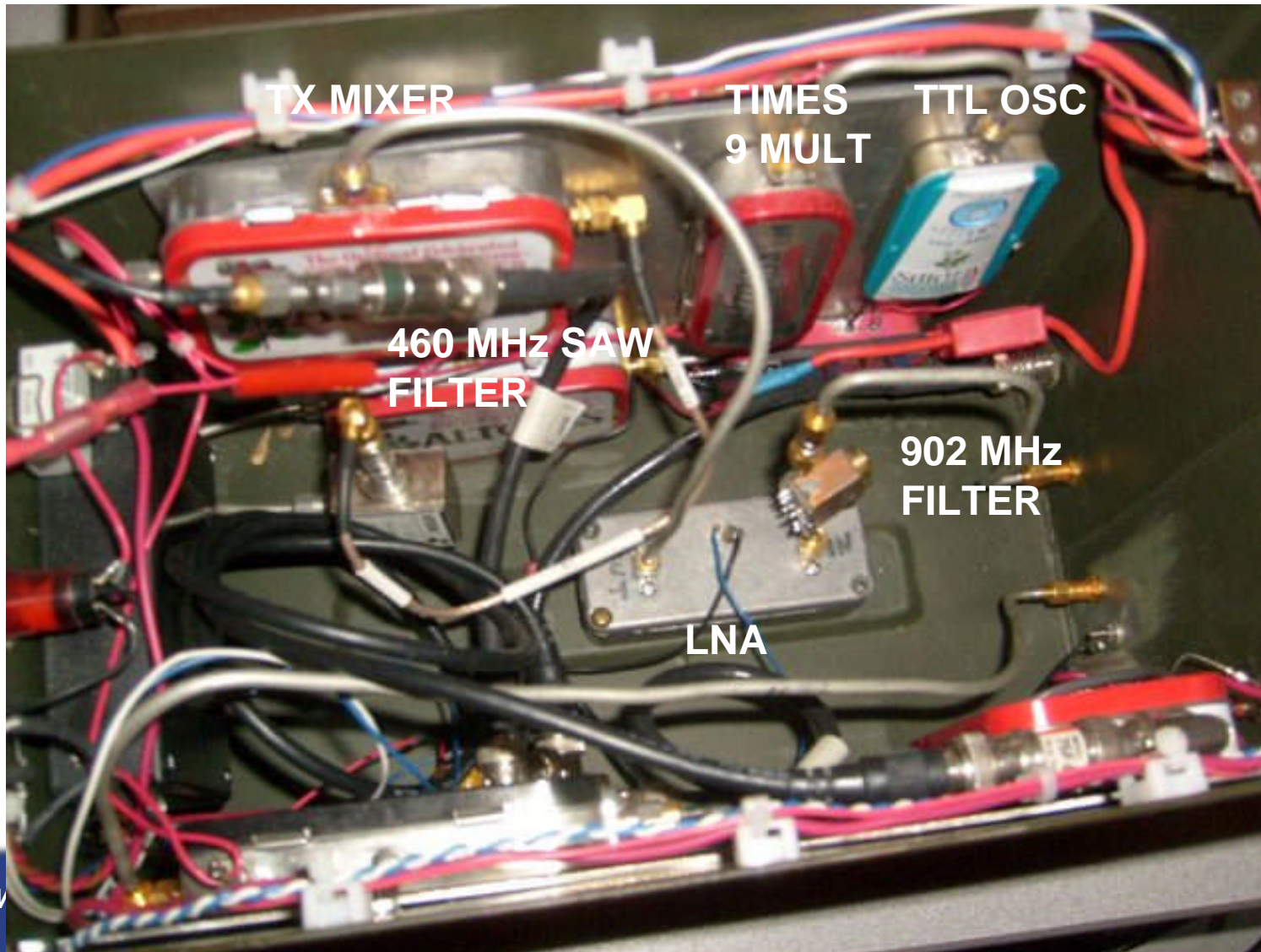
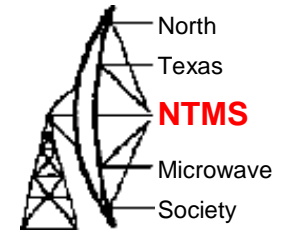

NM5M's 902 MHz XVTR

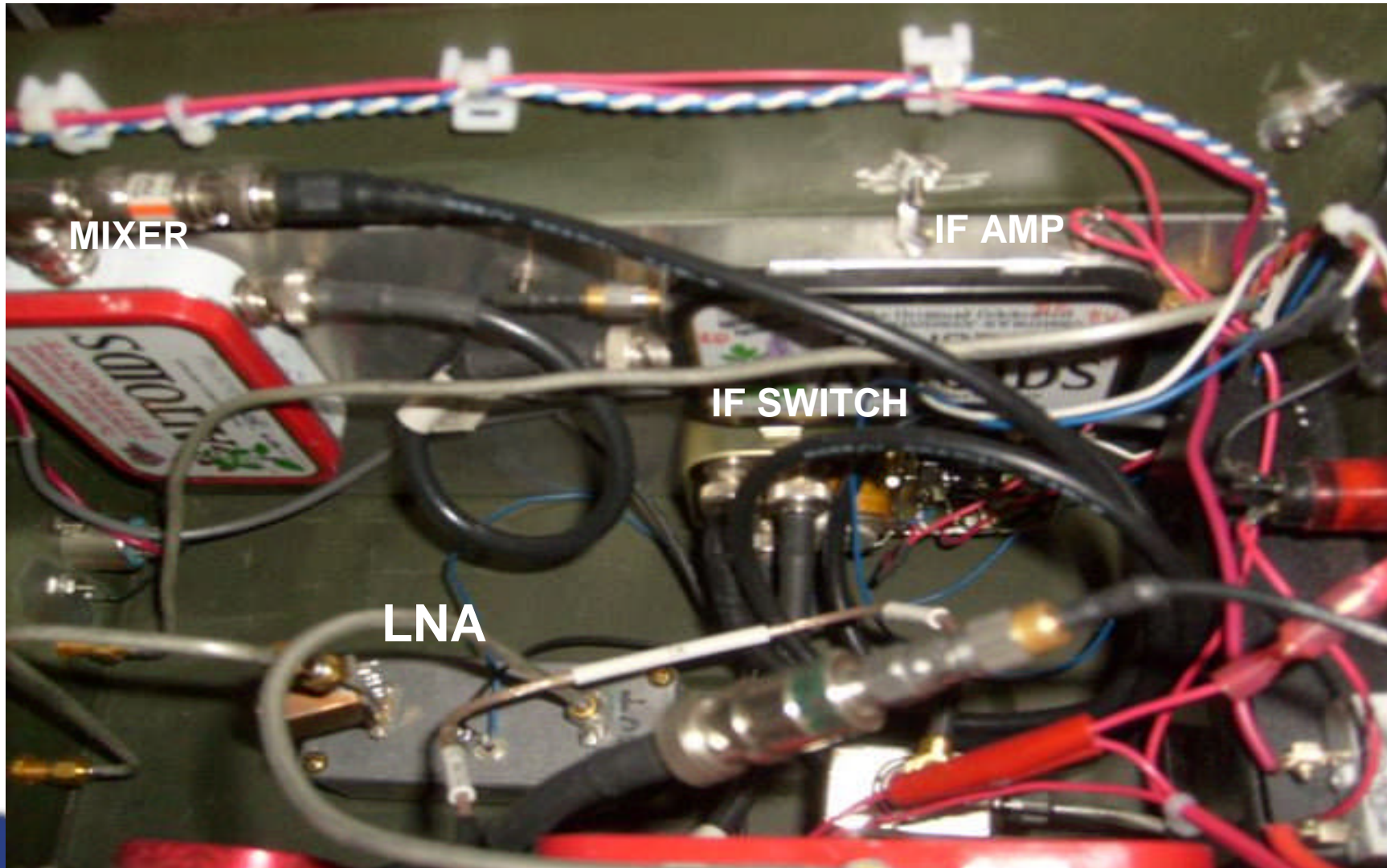
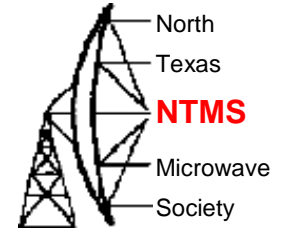

WB5ZDP 902 MHz Transverter

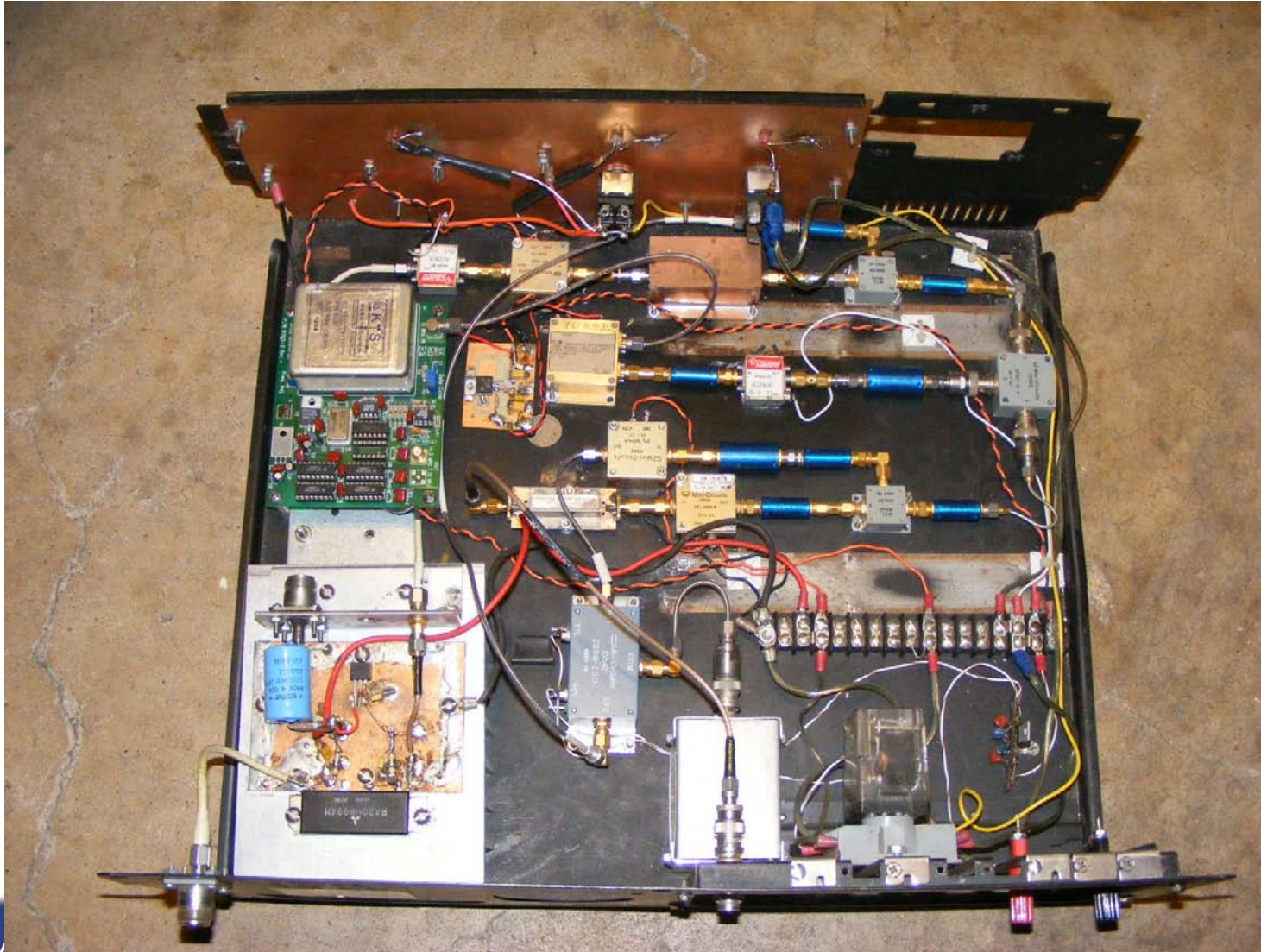
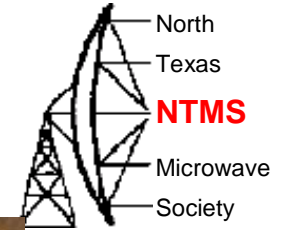

W1GHZ 902 MHz Transverter

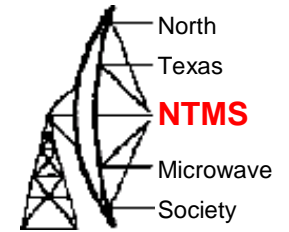

- Inexpensive 2 board approach providing low power and moderate NF
- http://www.w1ghz.org/MBT/902_MHz_Transverter_for_the_Multiband_Rover.pdf
- Group Buy?

150 Watt Motorola SSPA Model STF2520A

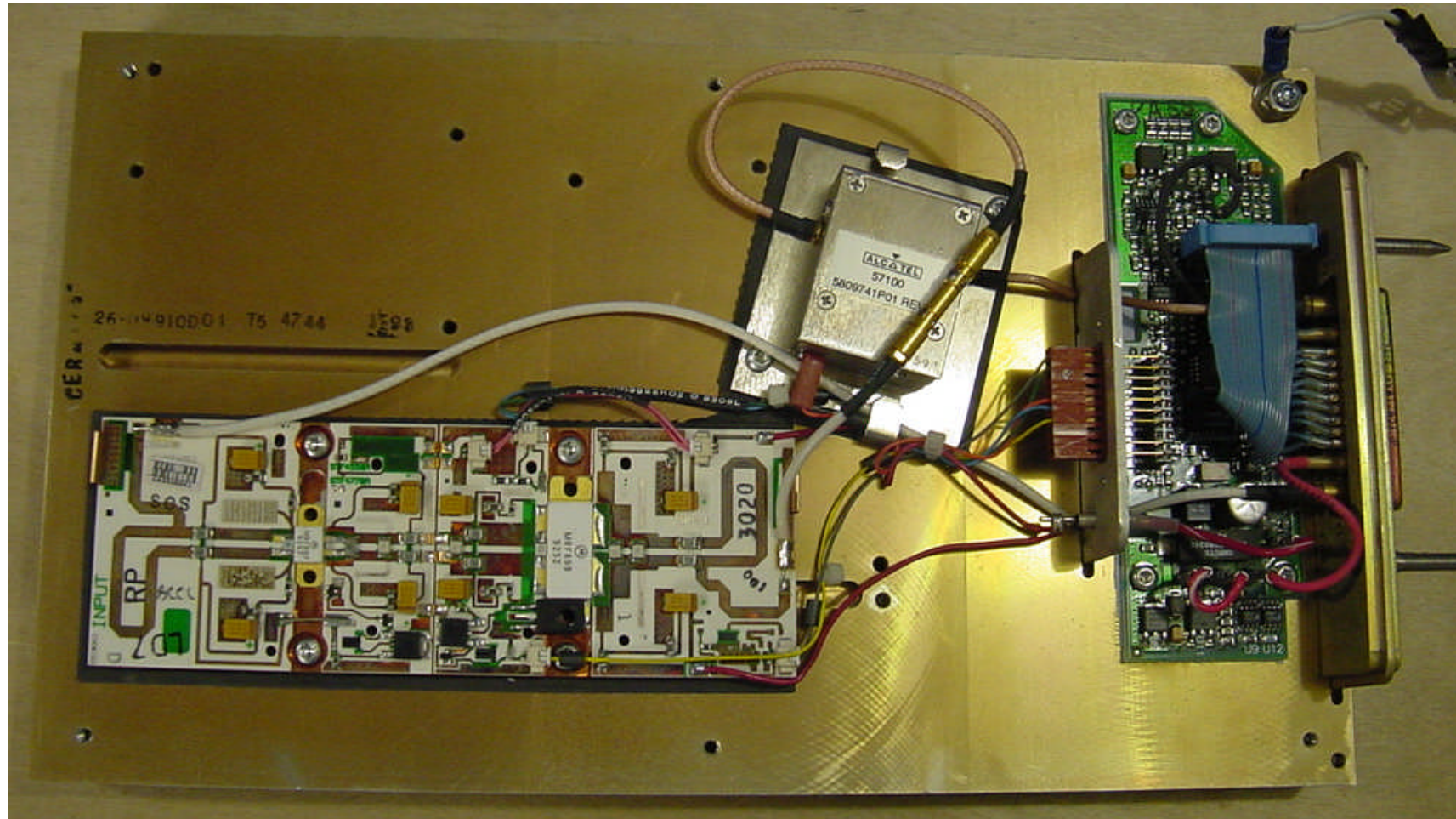
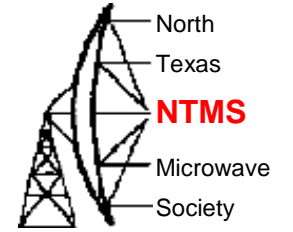

300 Watt Motorola SSPA Model SGTF 1038A

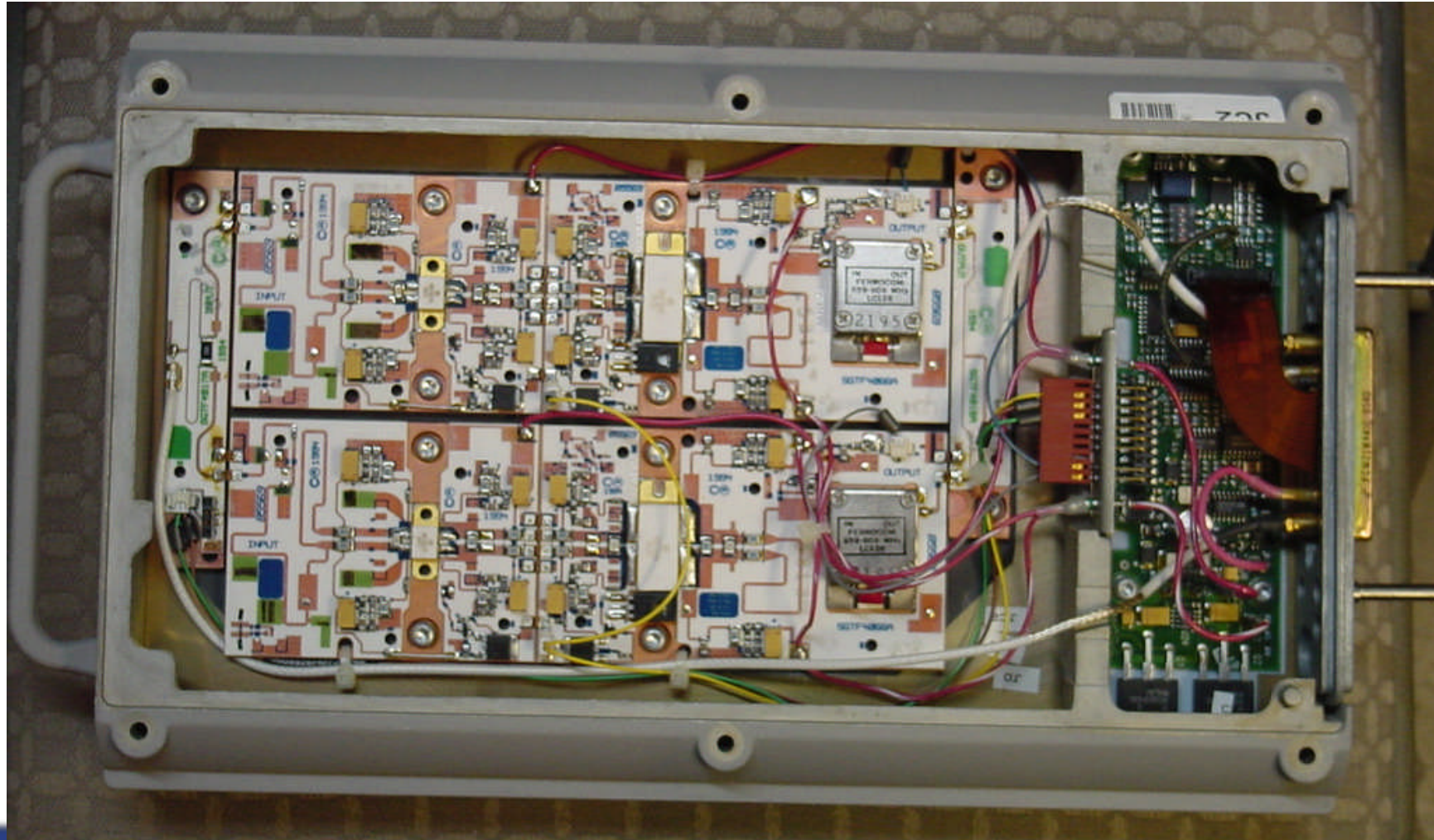
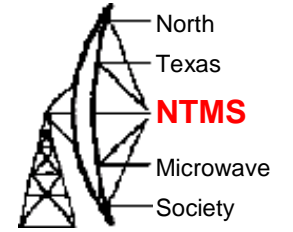

1 Watt Low Level Leveling Amplifier Model STF 2540A

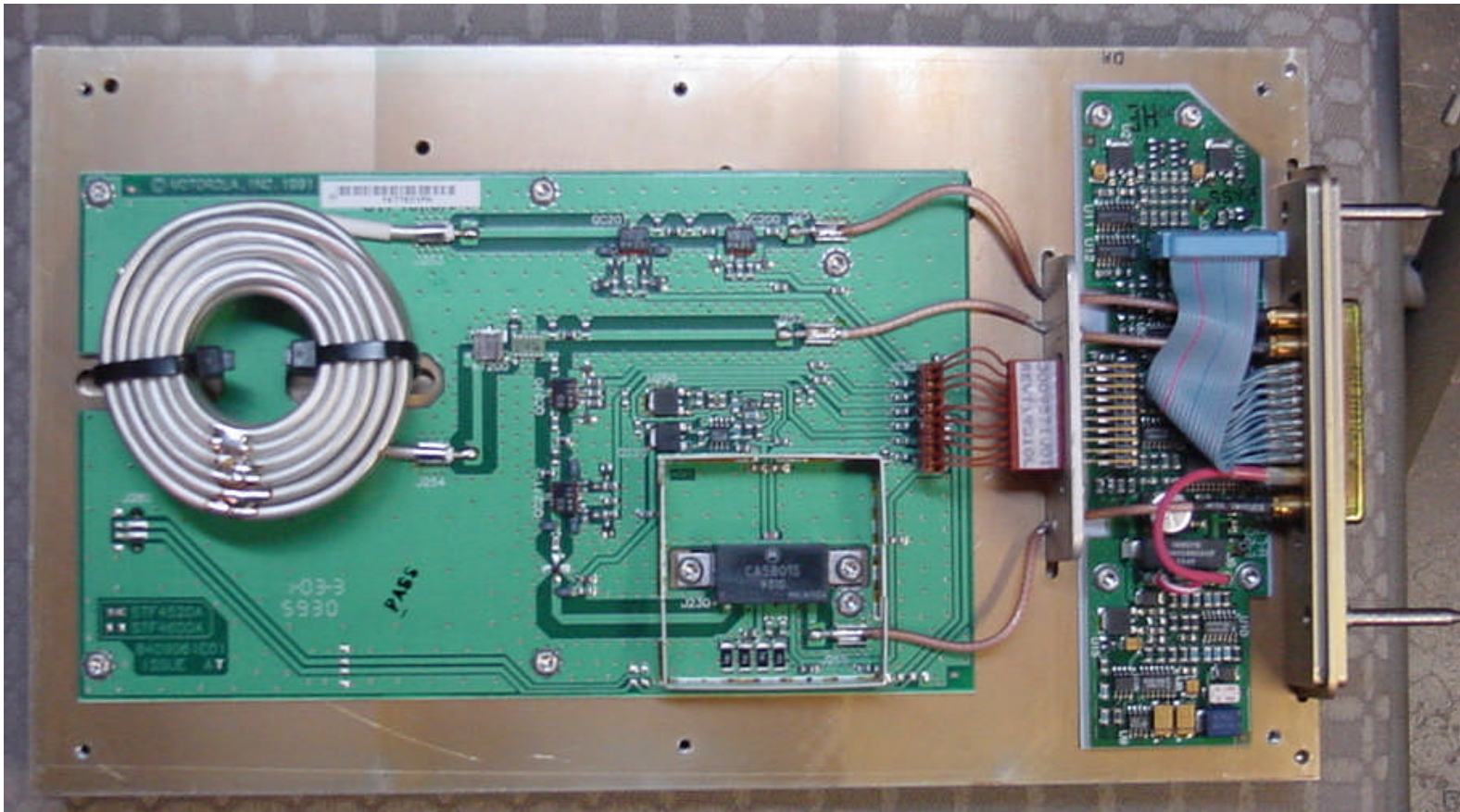
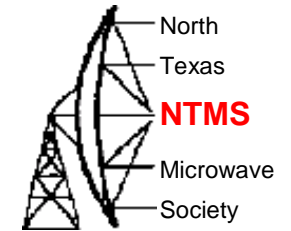

This unit is the same form factor as the 150 watt and 300 watts SSPAs – Buyer be aware!

Motorola 150 W and 300 W SSPAs

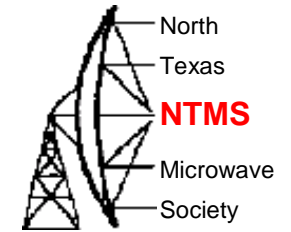

- www.vhfsouth.com modifications per KD5FZX on both 150W and 300W SSPAs
- Article by N5AC

W5LUA Pair 300W SSPA

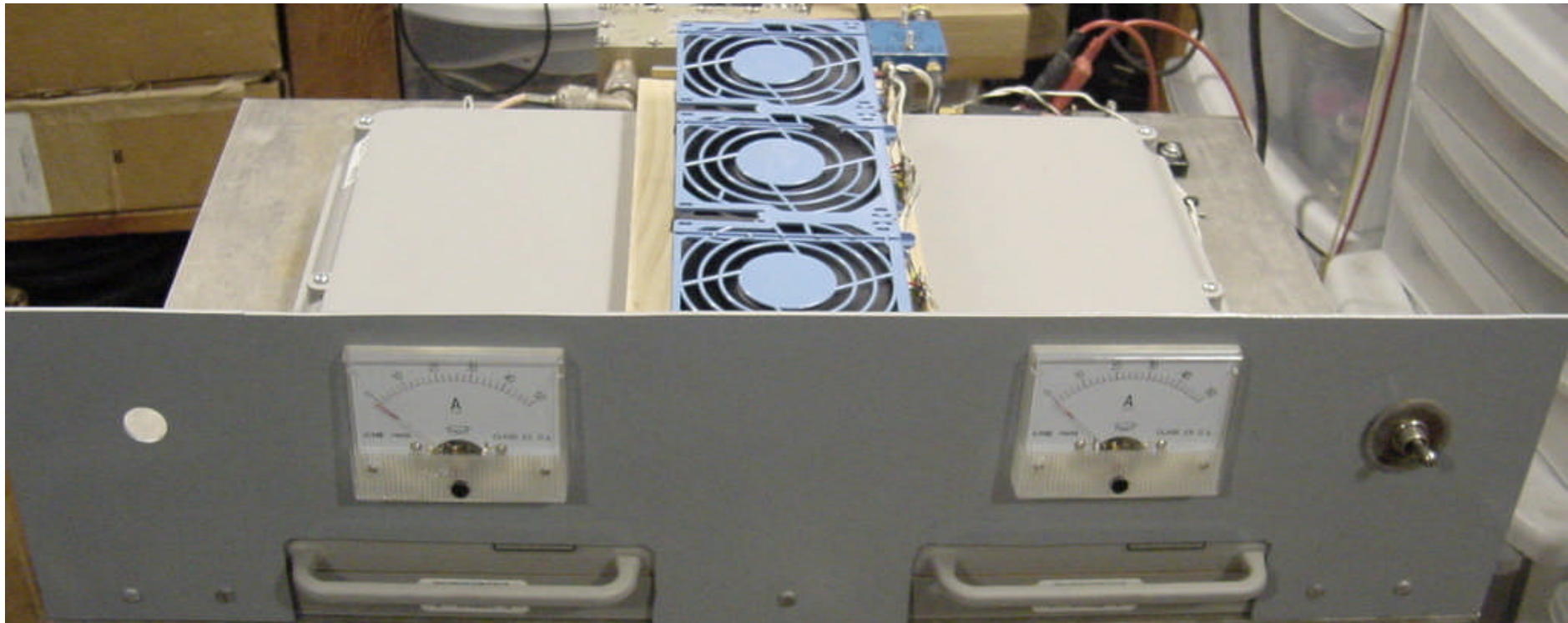
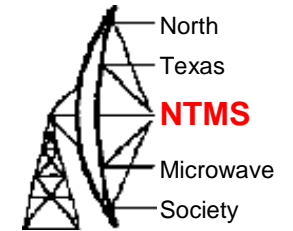

50 Amp meters and shunts available from www.allelectronics.com
\$12 / meter and \$12 / shunt

Back View SSPA

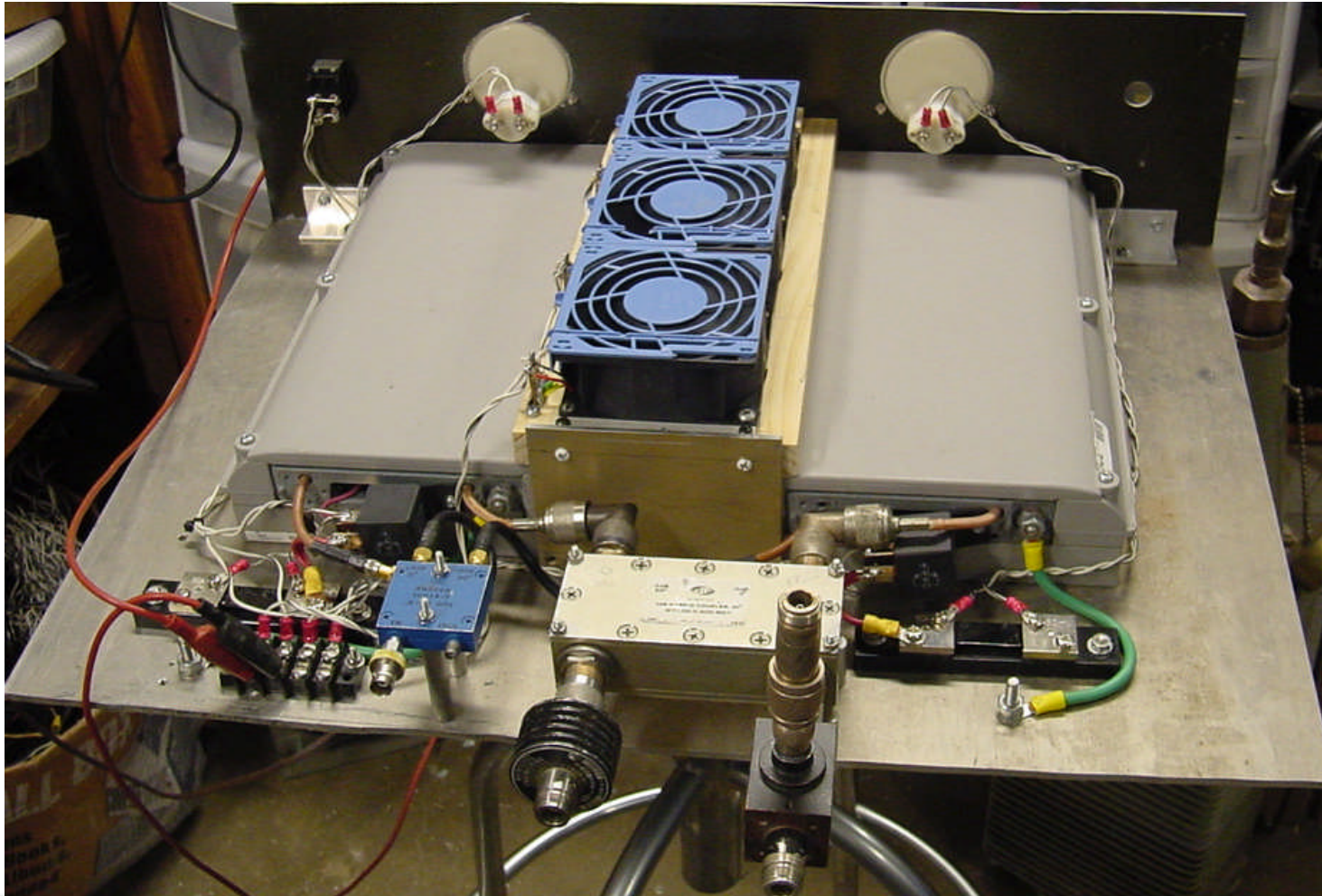

Close-Up Power Dividers

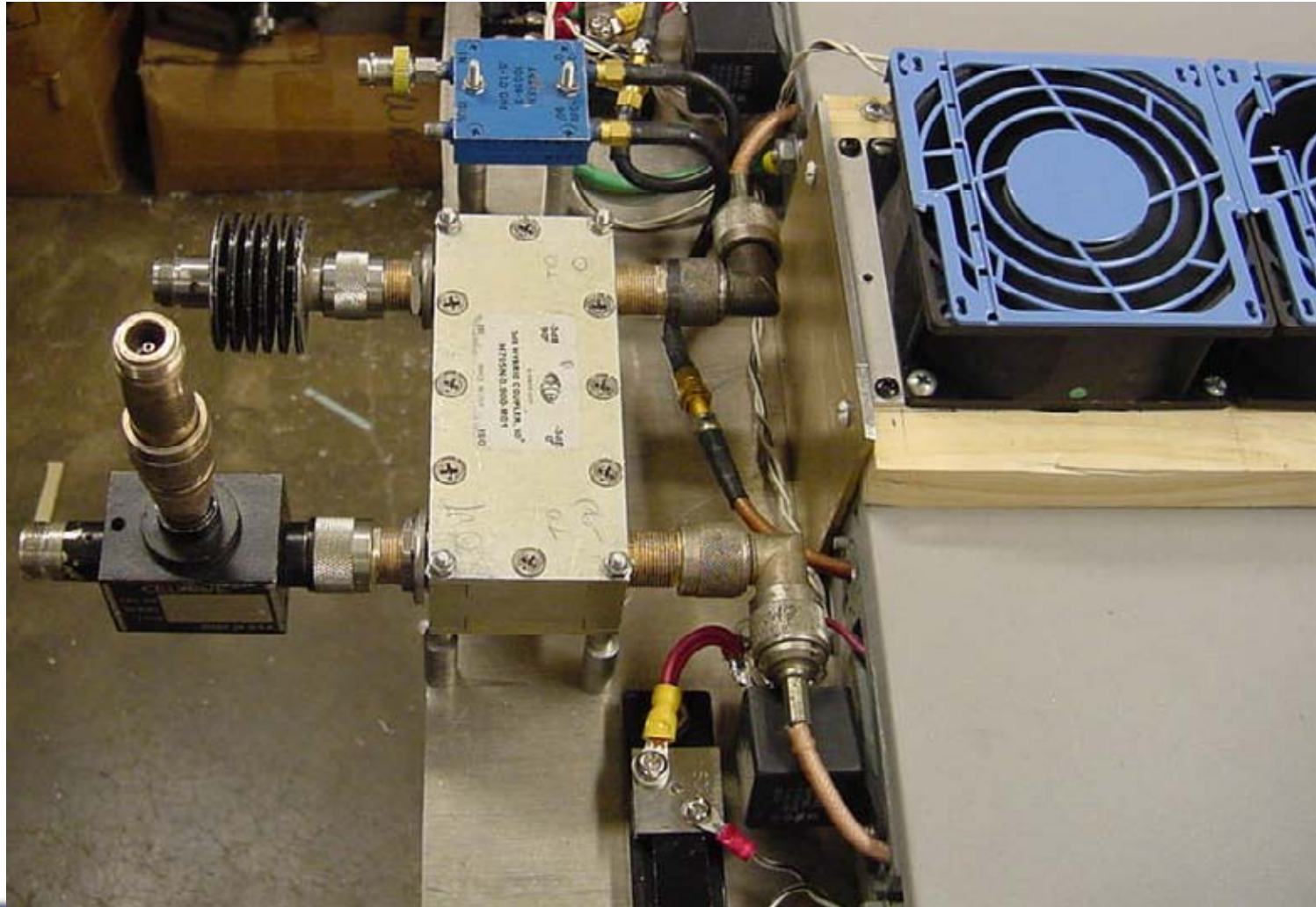

Paralleling two 300 Watt SSPAs at WA8RJF using 90 Degree Hybrid Couplers

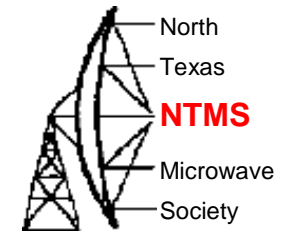

Showing Method of Attachment of 24V and PTT at WA8RJF

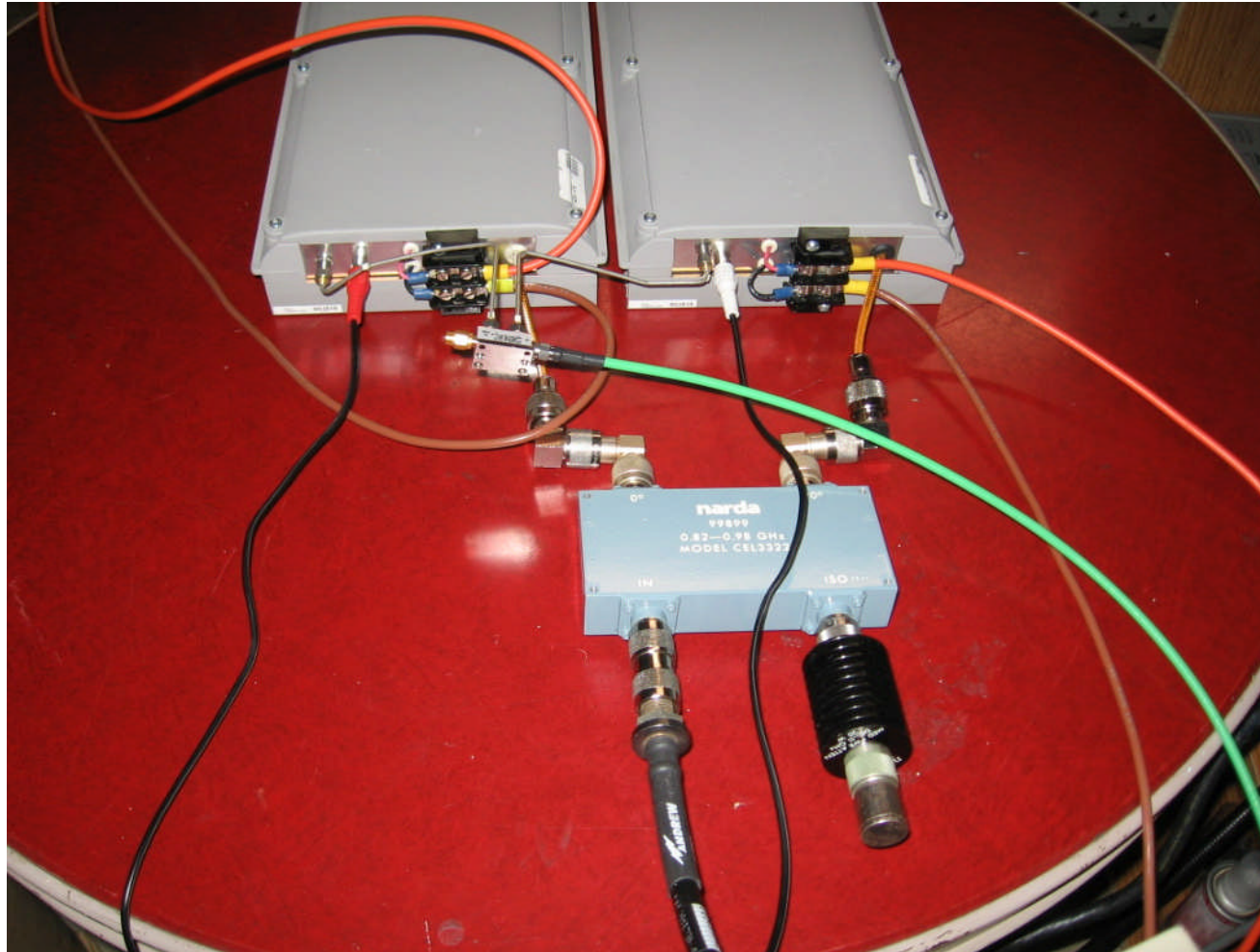
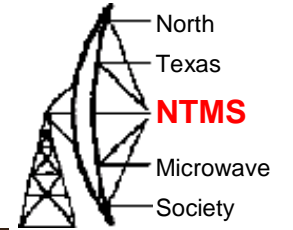

SMA 90 Degree Hybrid Couplers

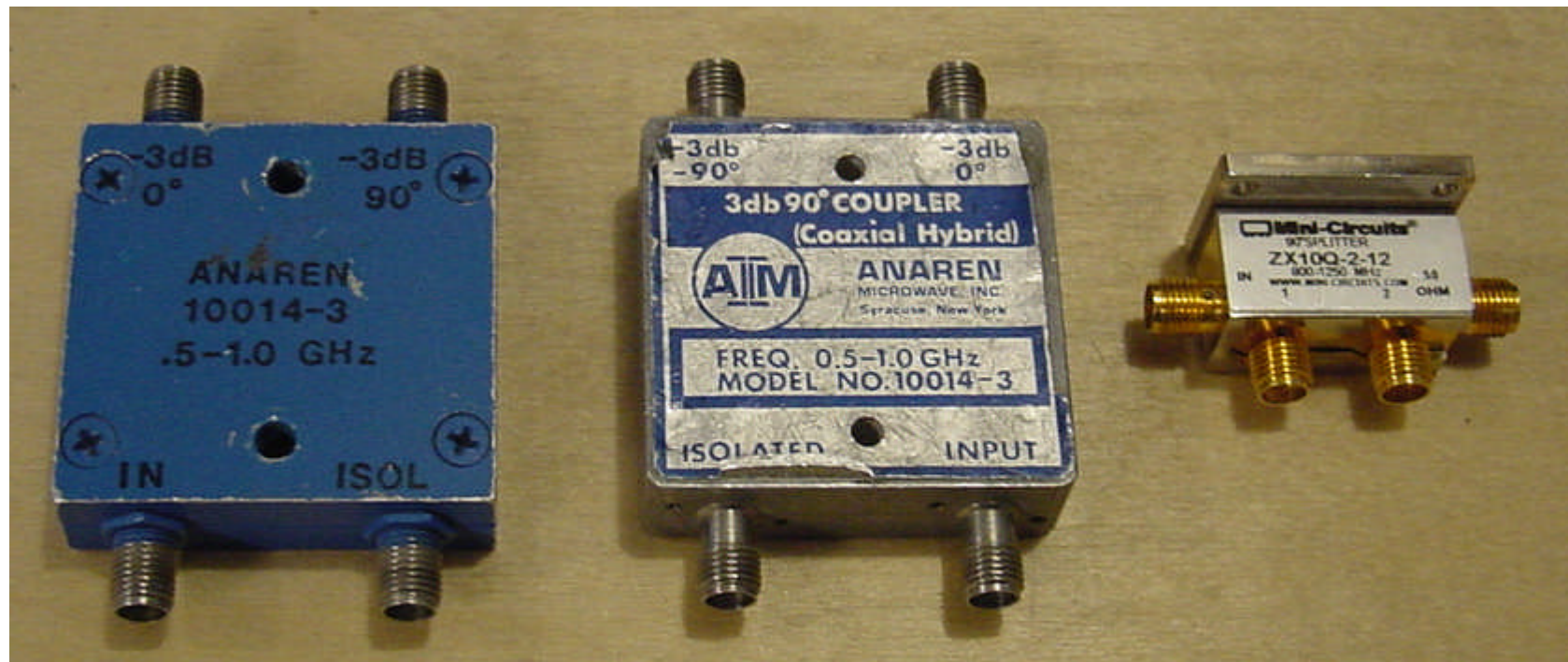
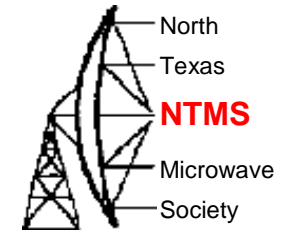

Anaren 10014-3 .5 to 1 GHz 3dB 90° Hybrid

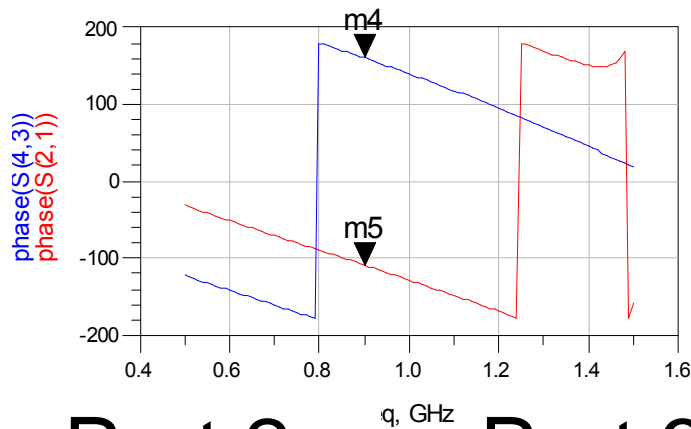
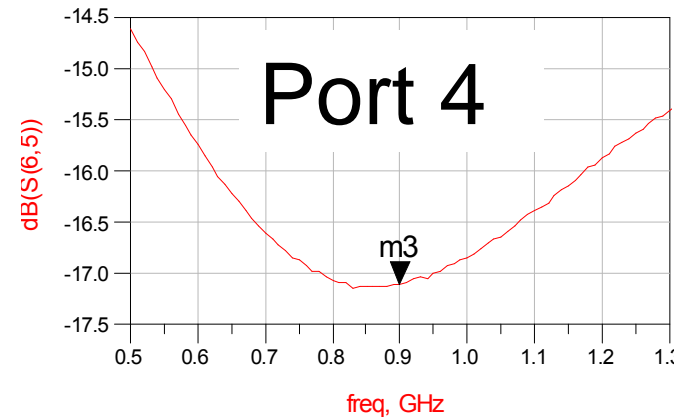
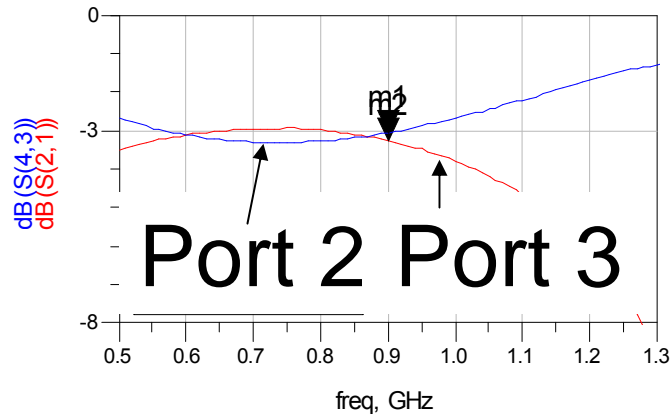
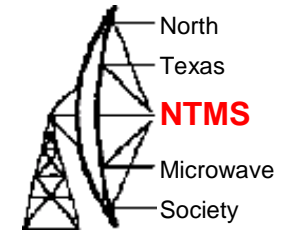

Port 2
-109°

Port 3
160.1°

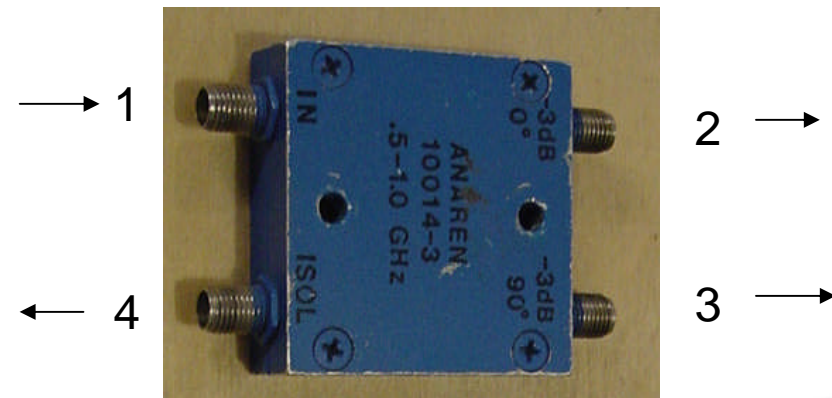

MECA 900 MHz 3dB 90° Hybrid

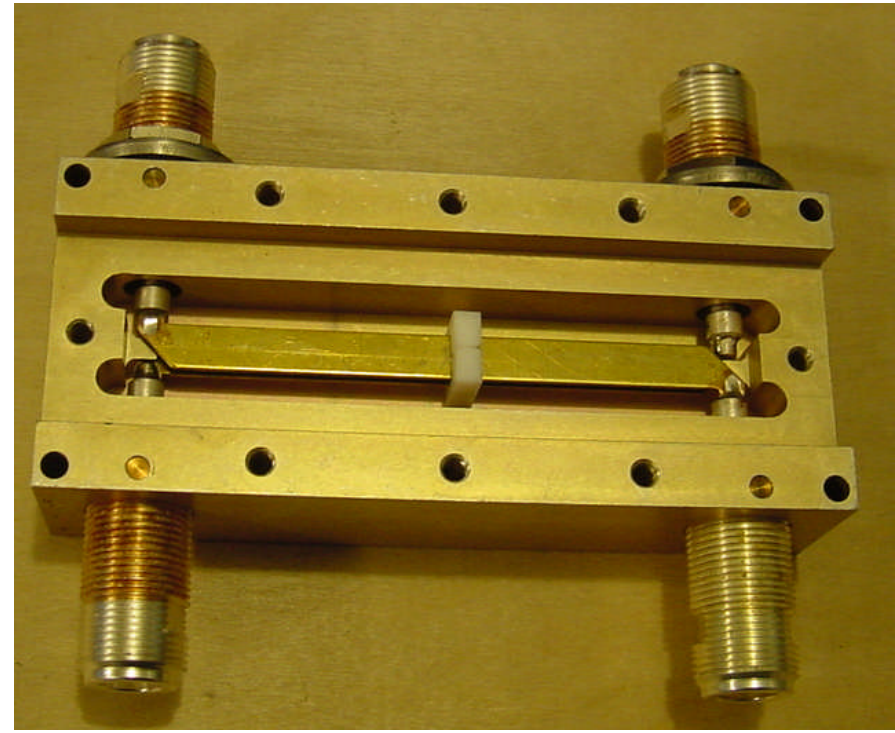
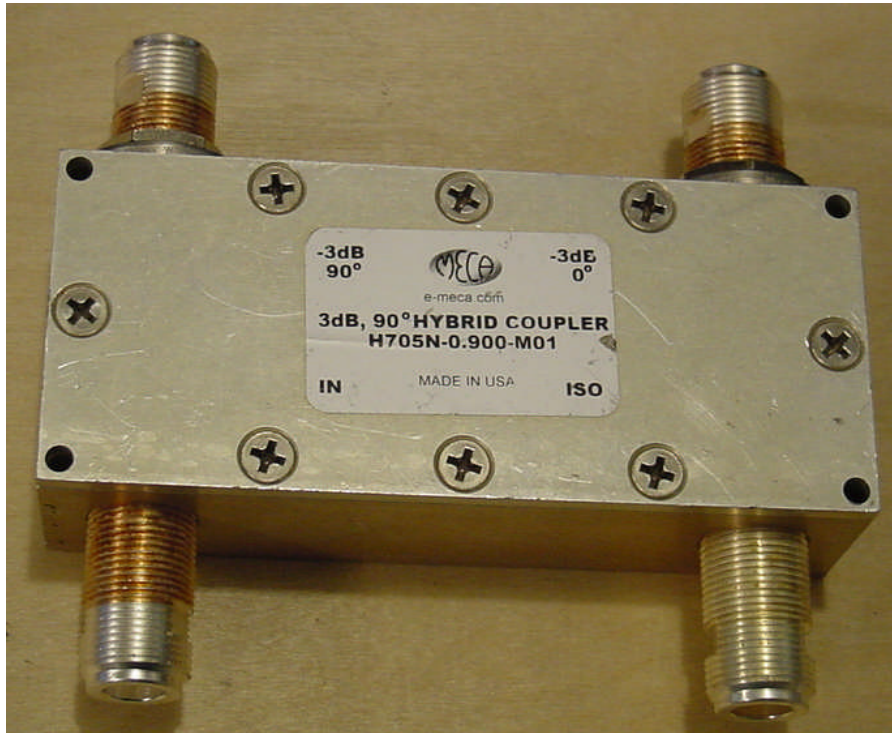
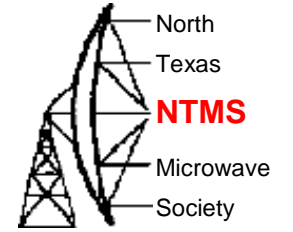

MECA 900 MHz 3dB 90° Hybrid

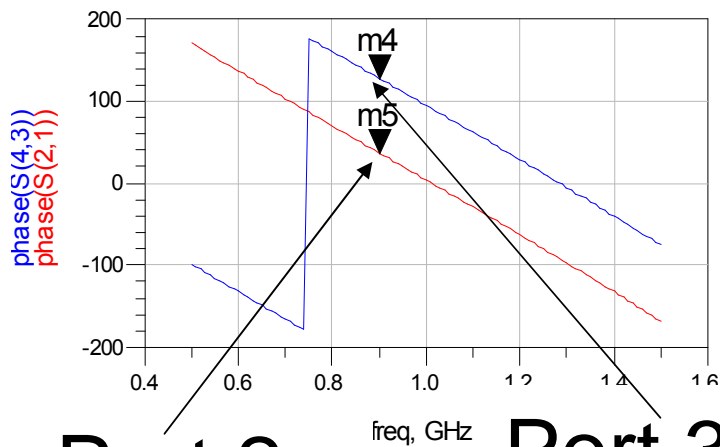
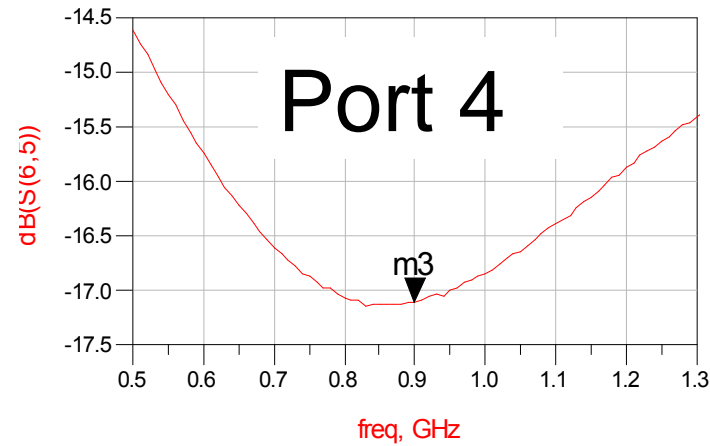
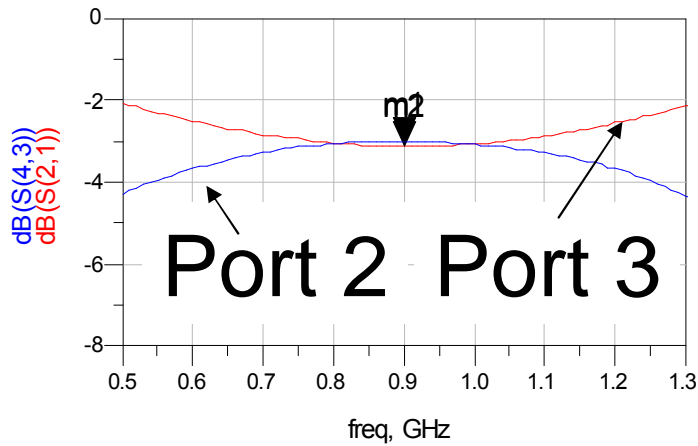
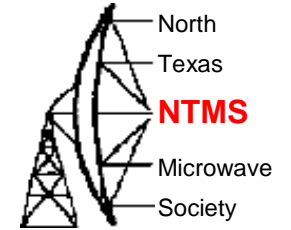

Port 2

36.7°

Port 3

127.7°

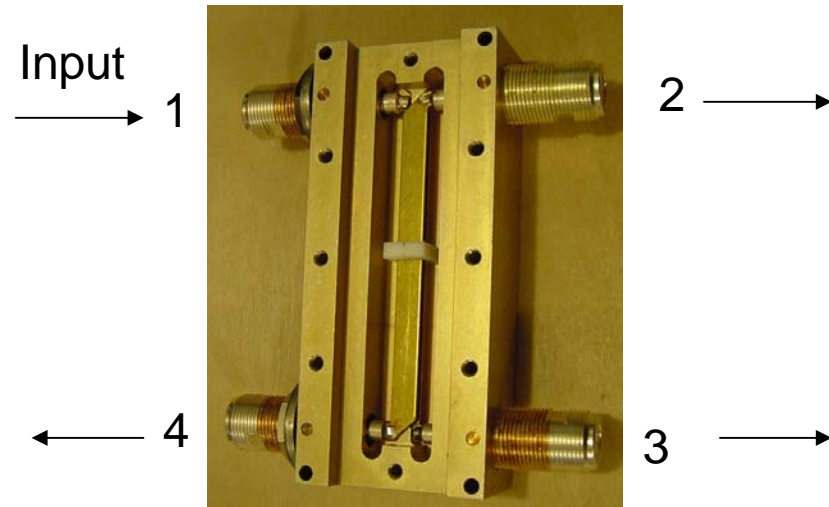

Difference = 127.7-36.7=91°

ADS Coupler Simulation

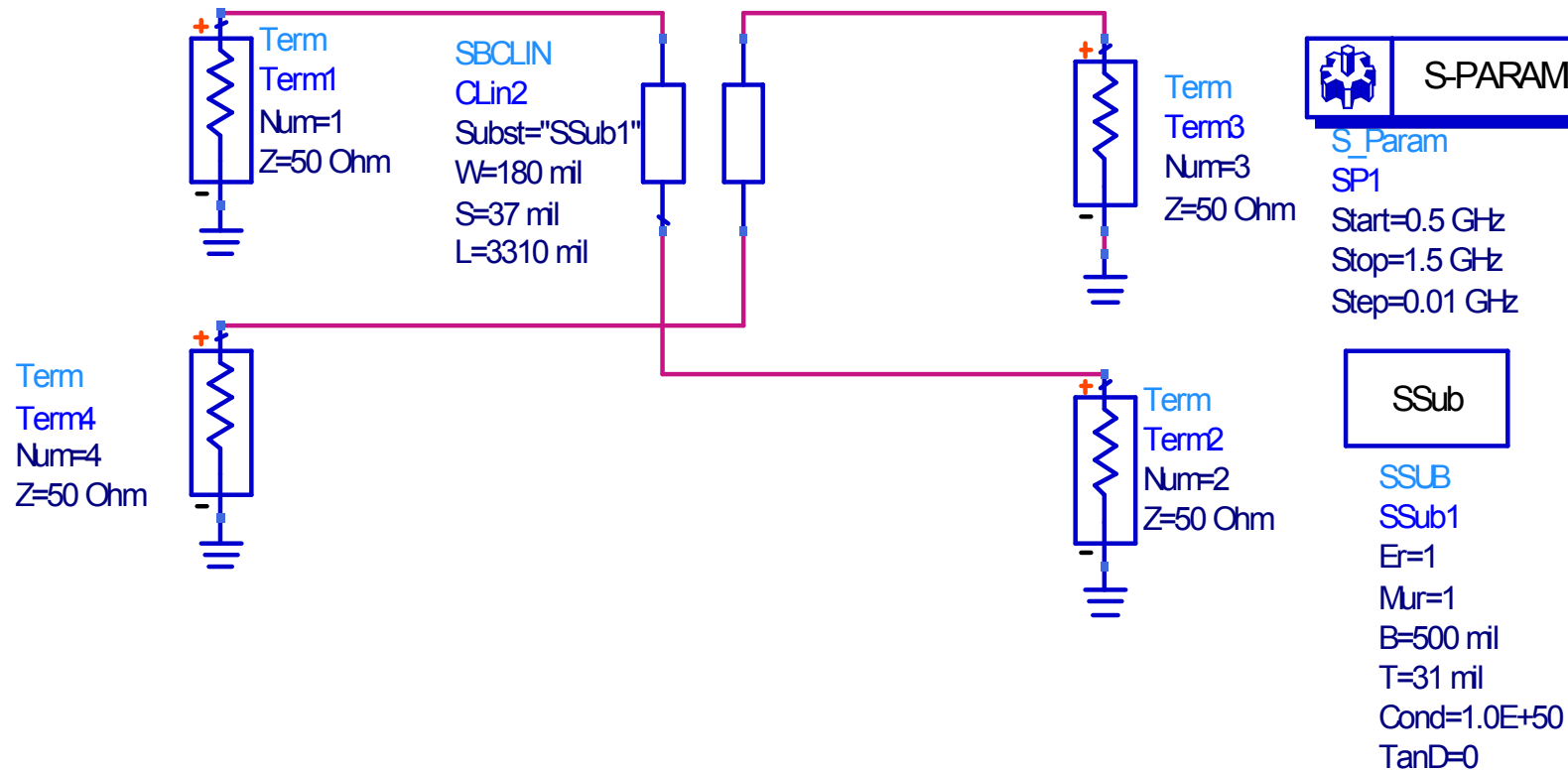
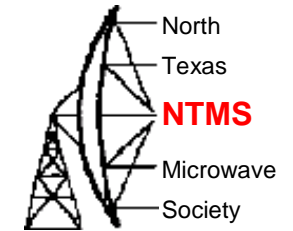

MECA 900 MHz 3dB 90° Hybrid ADS Simulation

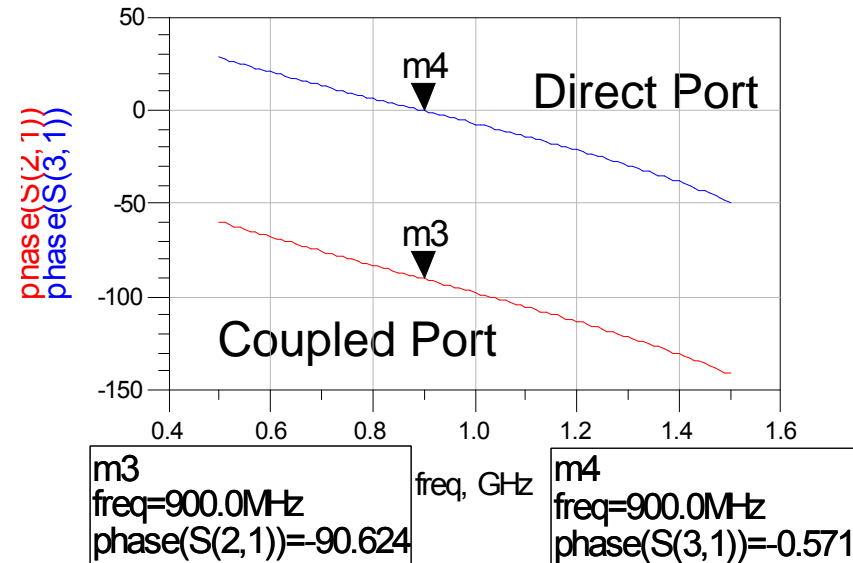
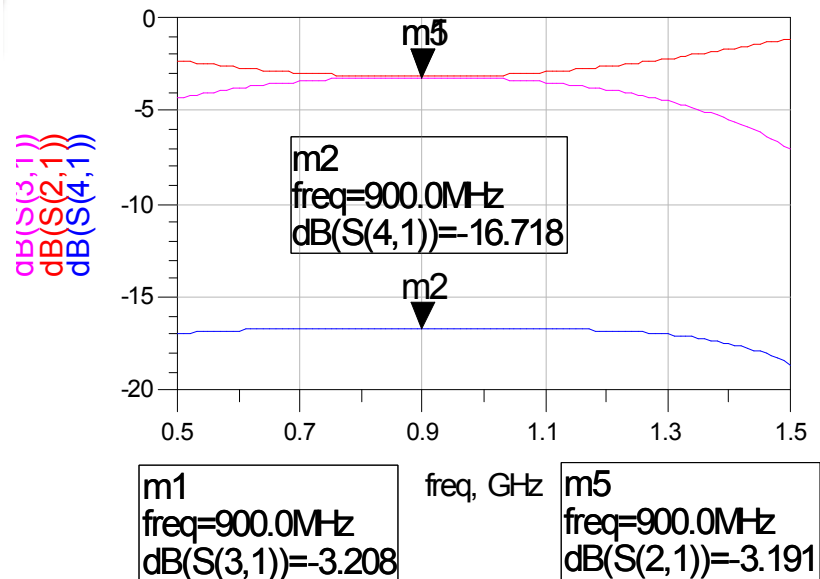
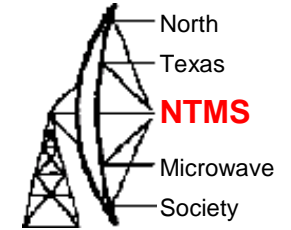

Directivity = Isolation – Coupling =
 $16.7\text{dB} - 3.2\text{dB} = 13.5\text{dB}$ not too
 spectacular but may not be too
 important since we are not trying to
 accurately measure return loss but
 rather just combine amplifiers

Coupled port leads by 90 degrees
 Or direct port lags by 90 degrees

Broad band Response of the Ideal 90 Degree Hybrid

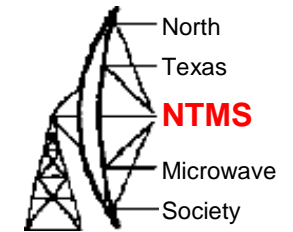

Also known as a “Backward Wave” Coupler

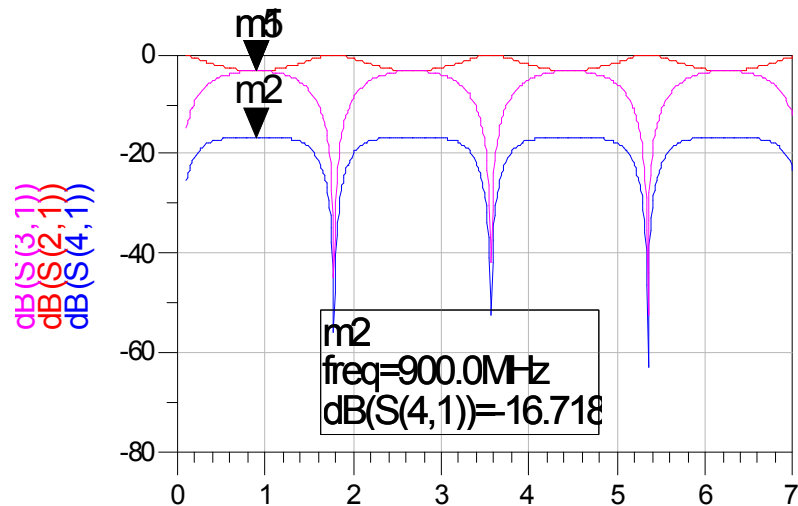

m1
freq=900.0MHz
dB(S(3,1))=-3.208

freq, GHz

m5
freq=900.0MHz
dB(S(2,1))=-3.191

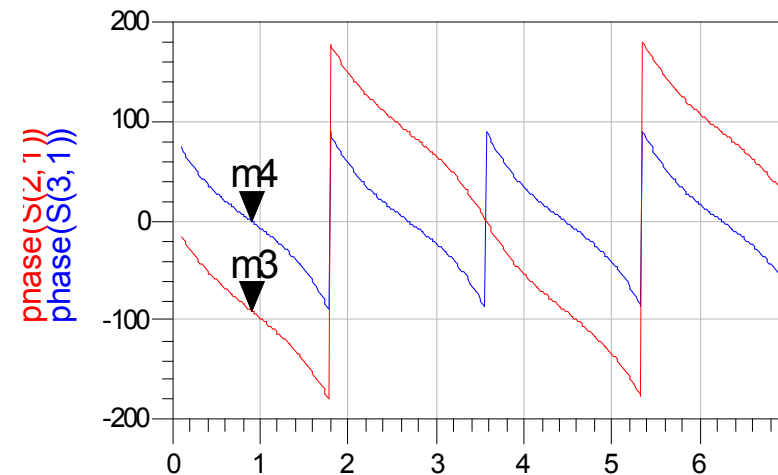

m3
freq=900.0MHz
phase(S(2,1))=-90.624

freq, GHz

m4
freq=900.0MHz
phase(S(3,1))=-0.571

Amplitude response repeats at $3f_0$, $5f_0$, $7f_0$, etc.

Phase difference remains constant at 90 degrees regardless of frequency!

In reality discontinuities and parasitics can create imbalances

Cascade of 2 couplers

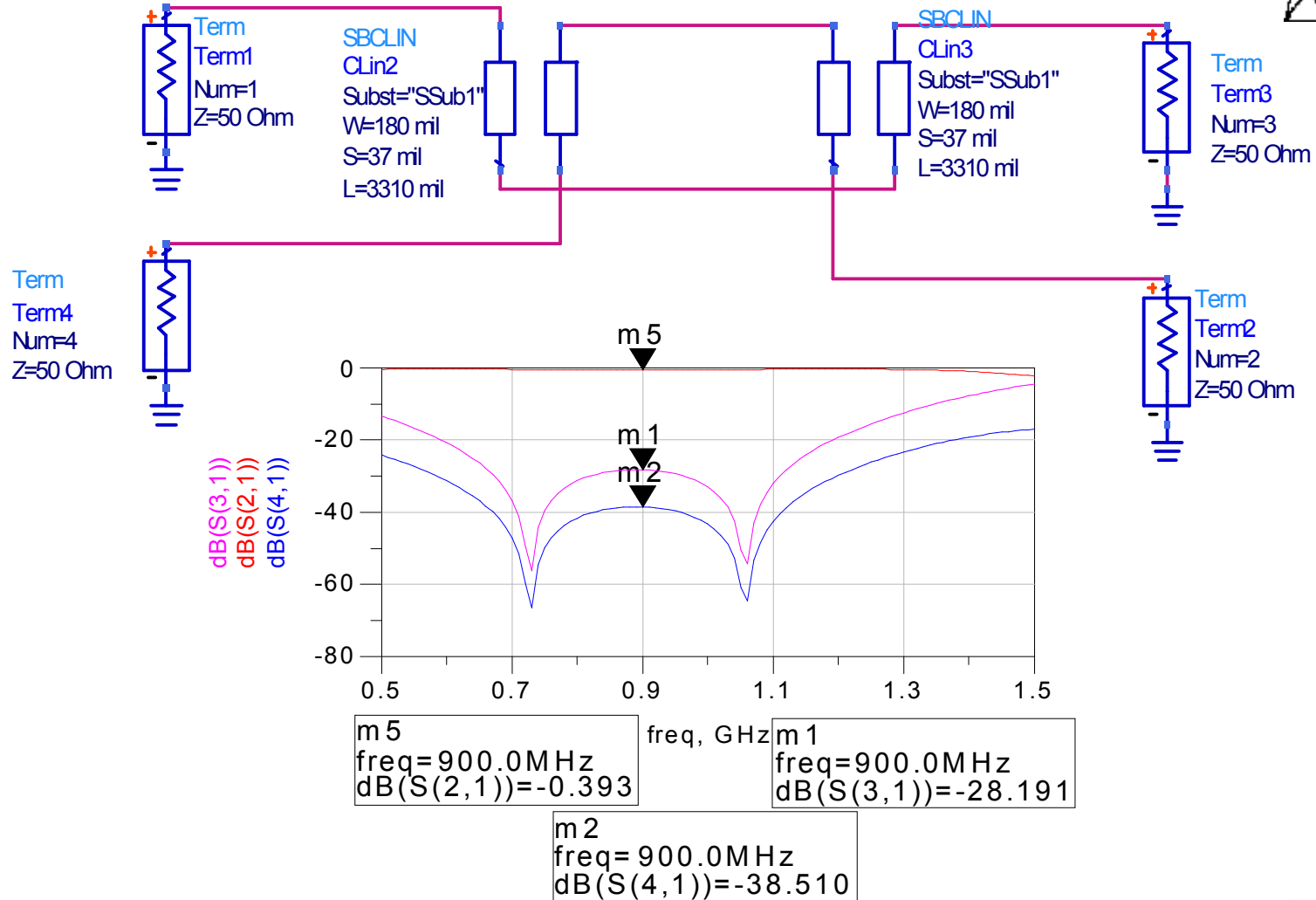
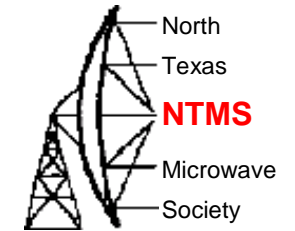

Cascade of 2 couplers with Open Circuit on one Port1

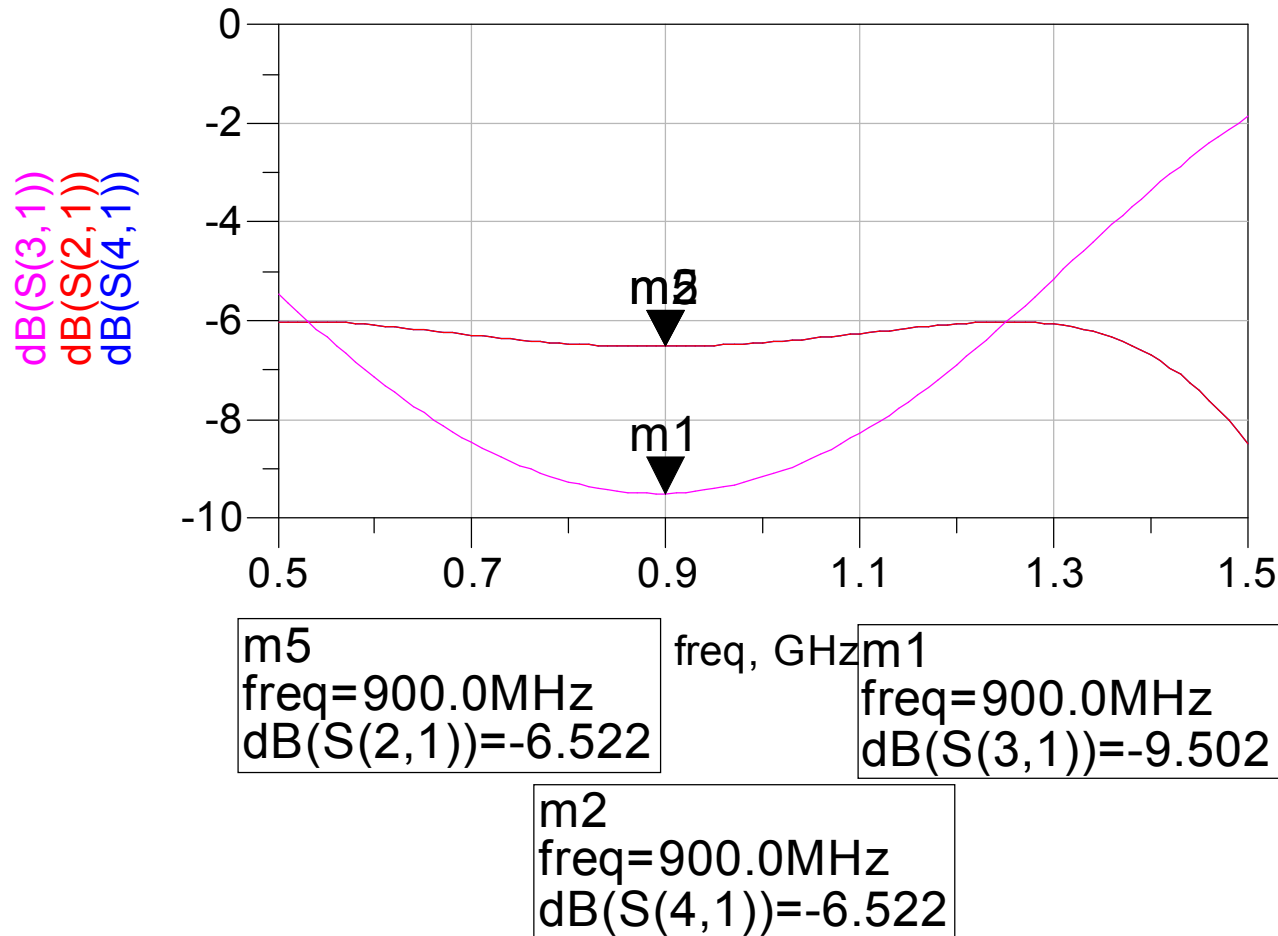
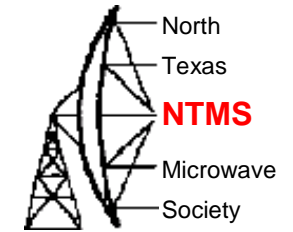

Through Loss = 6.5 dB
Power at isolated port down only 6.5 dB, need 50 ohm load that can handle this at least temporarily. In addition some power is also available at the "other" output port of the coupler – none of this is very good!

Cascade of 2 couplers with 1 and 3 dB attenuators in one path

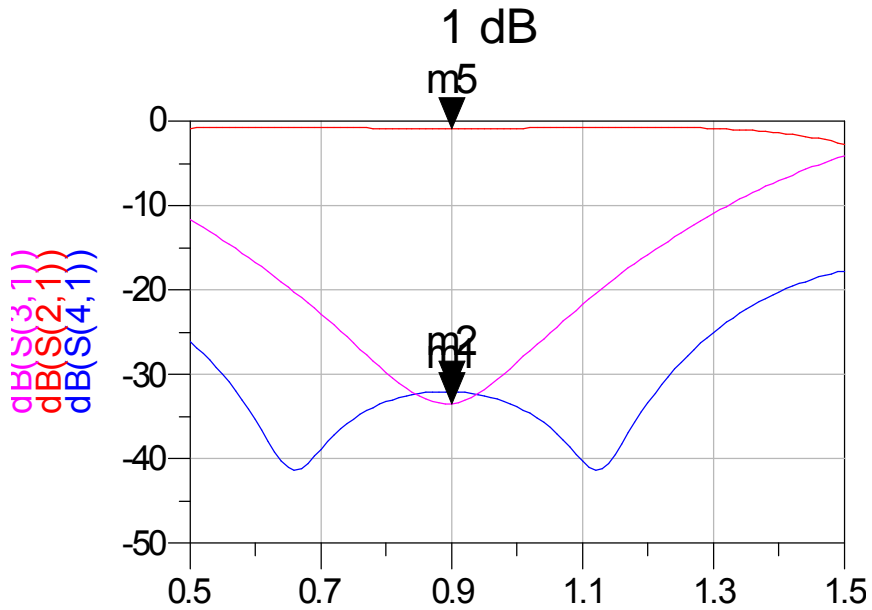
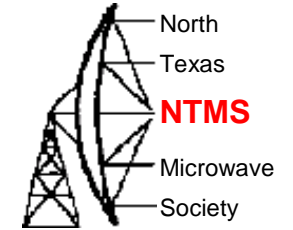

m5 freq=900.0MHz dB(S(2,1))=-0.873	freq, GHz	m1 freq=900.0MHz dB(S(3,1))=-33.422
--	-----------	---

m2 freq=900.0MHz dB(S(4,1))=-32.051

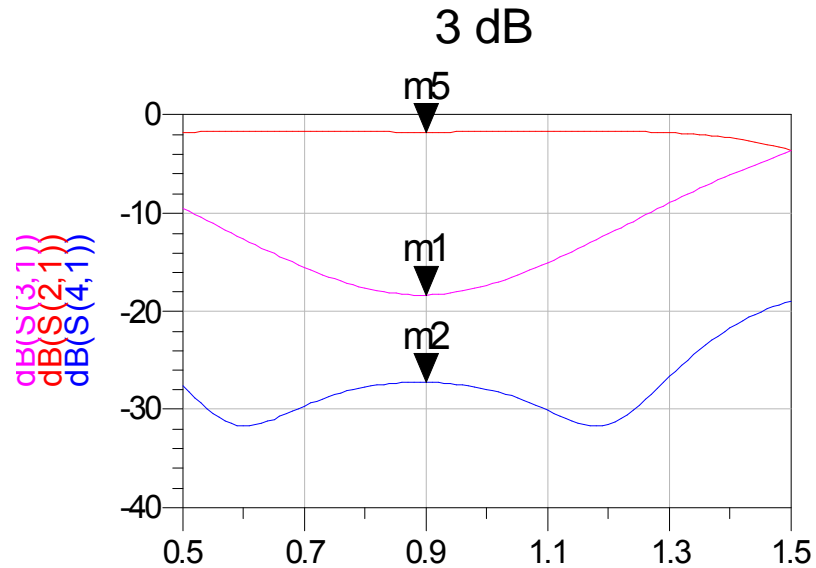

m5 freq=900.0MHz dB(S(2,1))=-1.741	freq, GHz	m1 freq=900.0MHz dB(S(3,1))=-18.343
--	-----------	---

m2 freq=900.0MHz dB(S(4,1))=-27.219

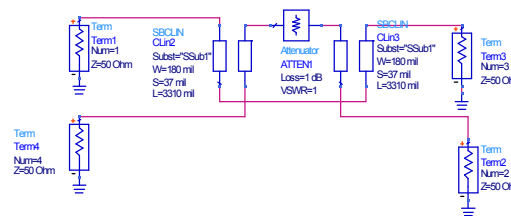

Cascade of 2 couplers with 10 and 45 degree offset in one path

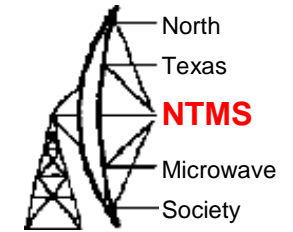

10 degree offset

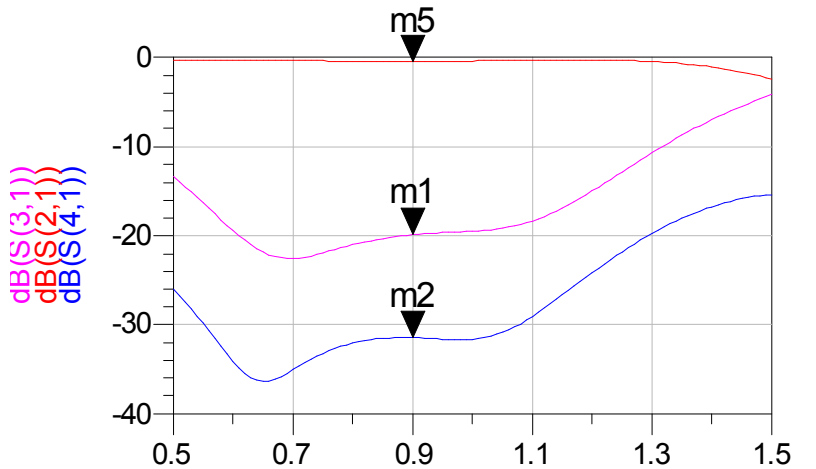

m5 freq=900.0MHz dB(S(2,1))=-0.429	freq, GHz	m1 freq=900.0MHz dB(S(3,1))=-19.919
--	-----------	---

m2
freq=900.0MHz
dB(S(4,1))=-31.472

45 degree offset

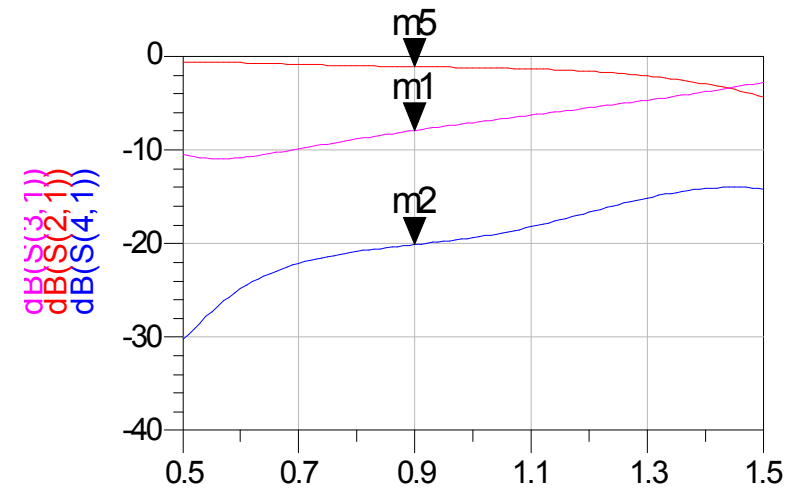

m5 freq=900.0MHz dB(S(2,1))=1.137	freq, GHz	m1 freq=900.0MHz dB(S(3,1))=7.941
---	-----------	---

m2
freq=900.0MHz
dB(S(4,1))=-20.145

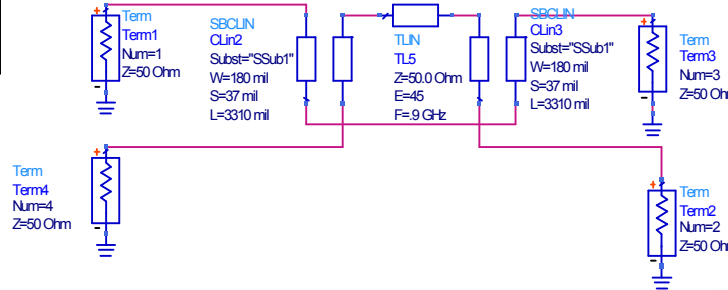

Single coupler with both outputs open circuited

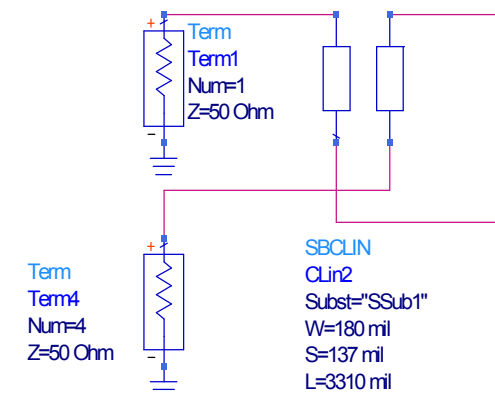
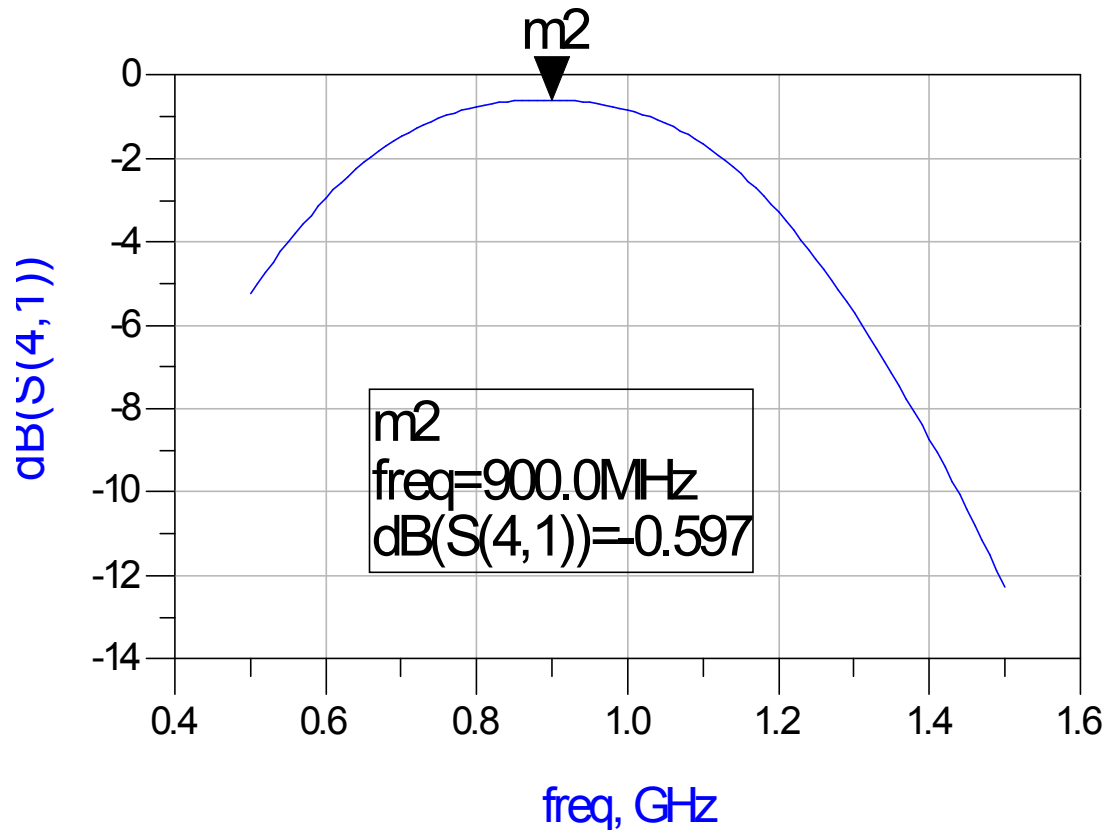
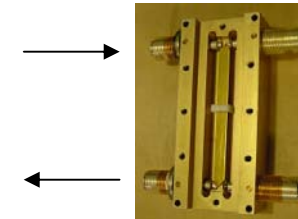
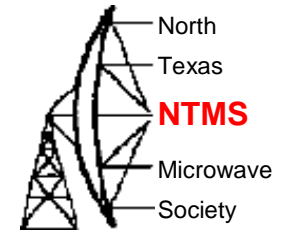

All power is reflected back to port 4.
Termination on port 4 must be capable of handling the entire available driver power.

Optimizing Power Output

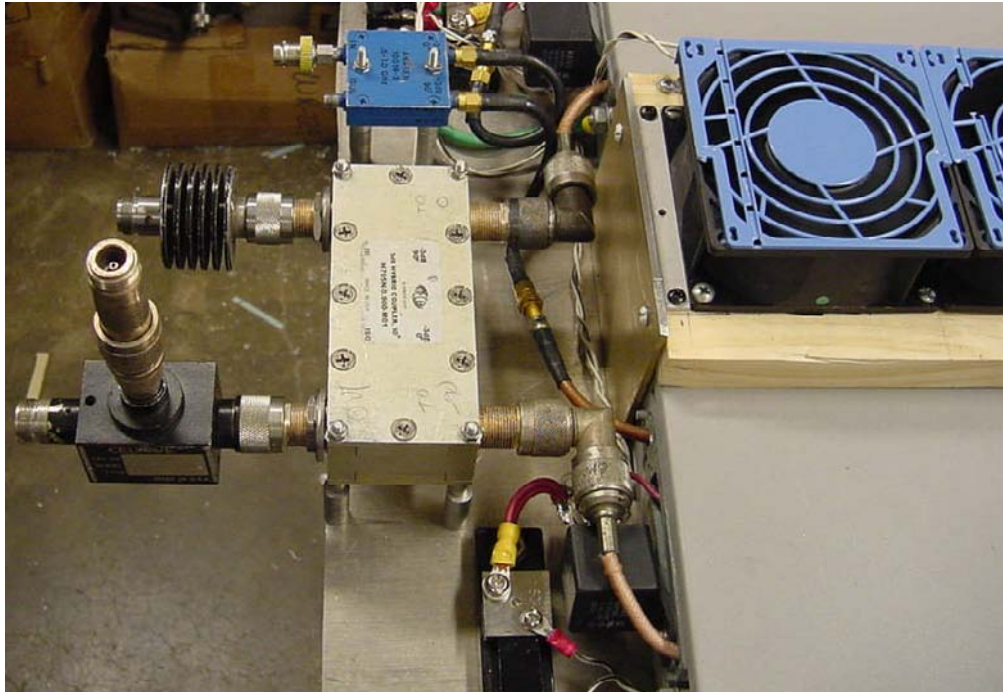
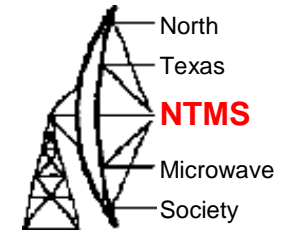

Best solution is to adjust amplitude and phase to keep current drawn by each amp as equal as possible when amps are driven to full power

Try flipping hybrids

Add some line length

Adjust load on output coupler isolated port

Each amp has some form of adjustable attenuator on its input

W0PW EIA Dual Dipole Feed

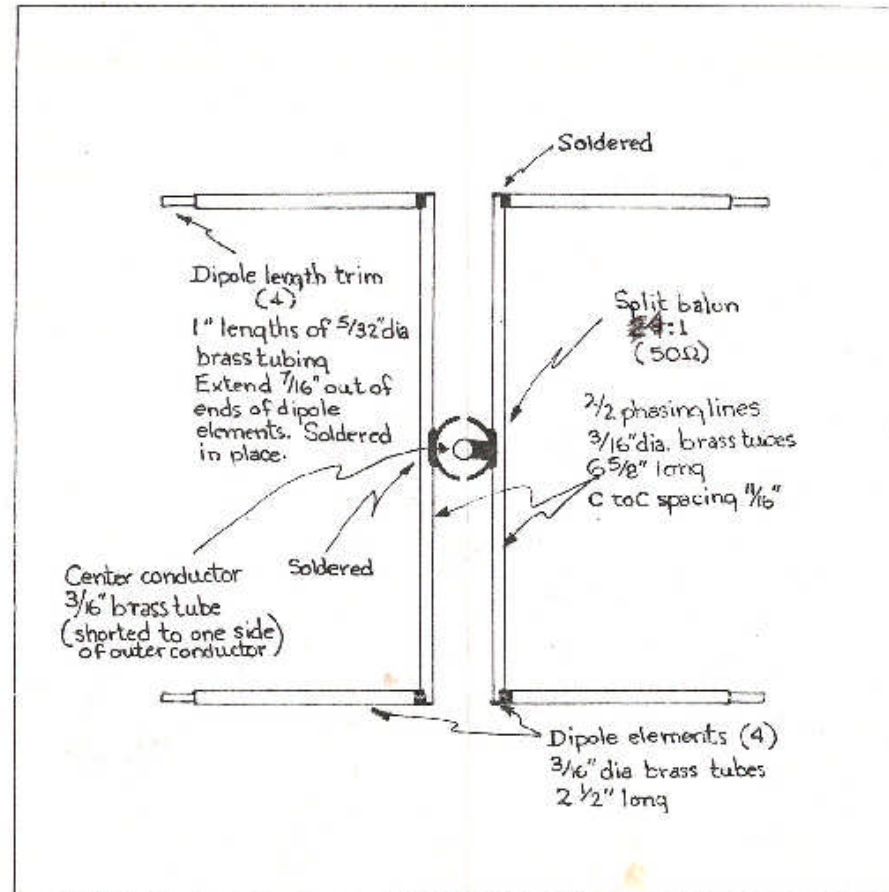
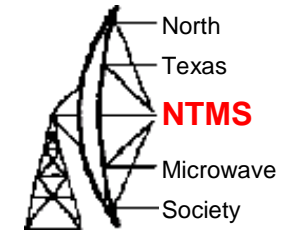

Reflector
Aluminum plate
1 3/8" square
1/16" alum.

TOP VIEW

DUAL DIPOLE
DISH FEED
FOR
902 MHz.
(NOT TO SCALE)

SHEET 1 OF 2
D Hilliard 1-88

W0PW EIA Dual Dipole Feed

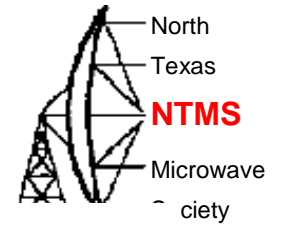

DUAL DIPOLE
DISH FEED
FOR
902 MHz.
(NOT TO SCALE)

SIDE VIEW

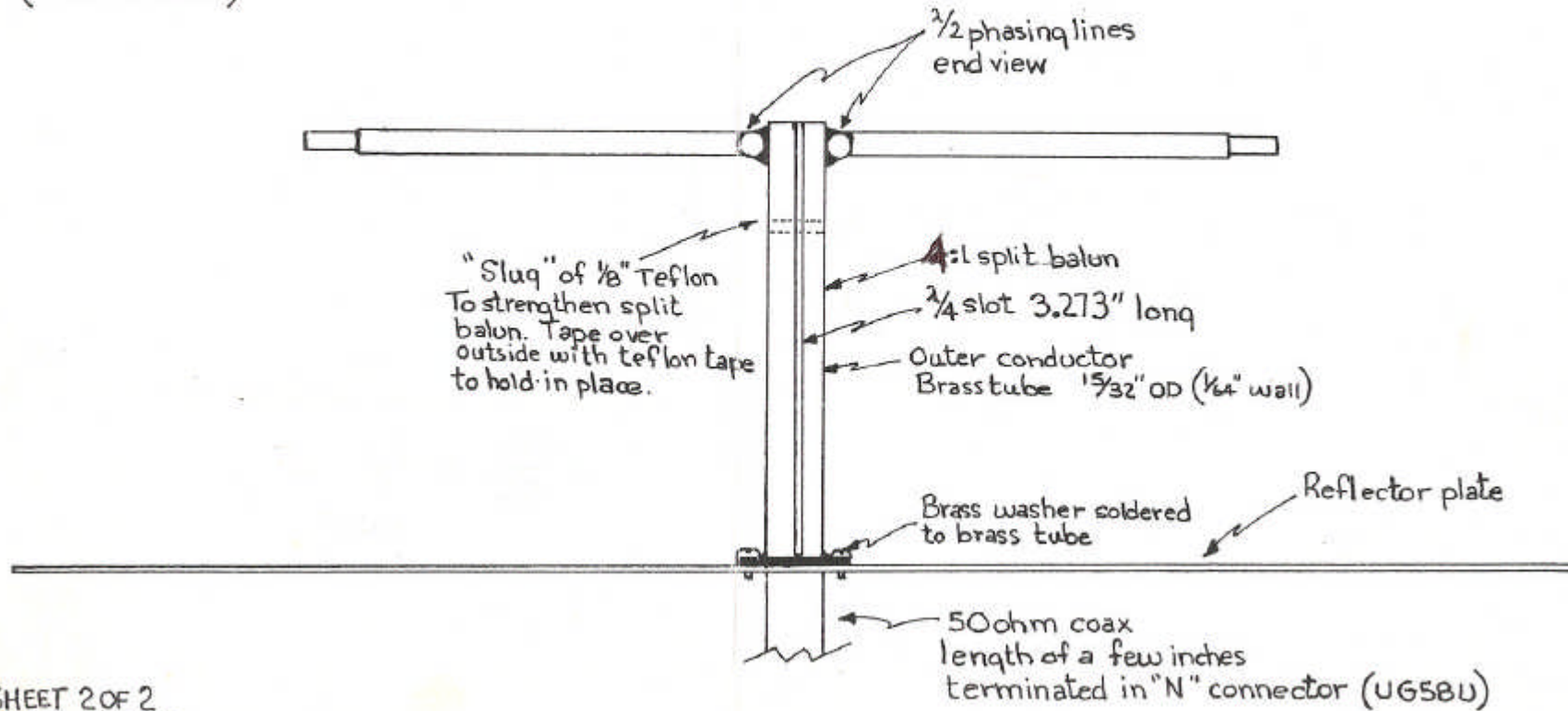

SHEET 2 OF 2
D Hilliard 1-88

902 MHz W0PW EIA Dual Dipole Feed @ W5LUA

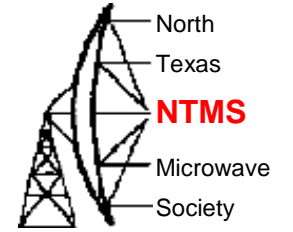

WA8RJF 3M Dish on 902 MHz

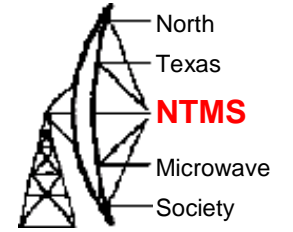

Dual Dipole Feed for 902 MHz Built by WW2R

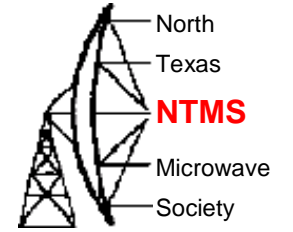

Side View of Dual Dipole Feed

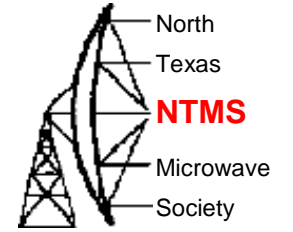

Return Loss of 902 MHz Dual Dipole Feed

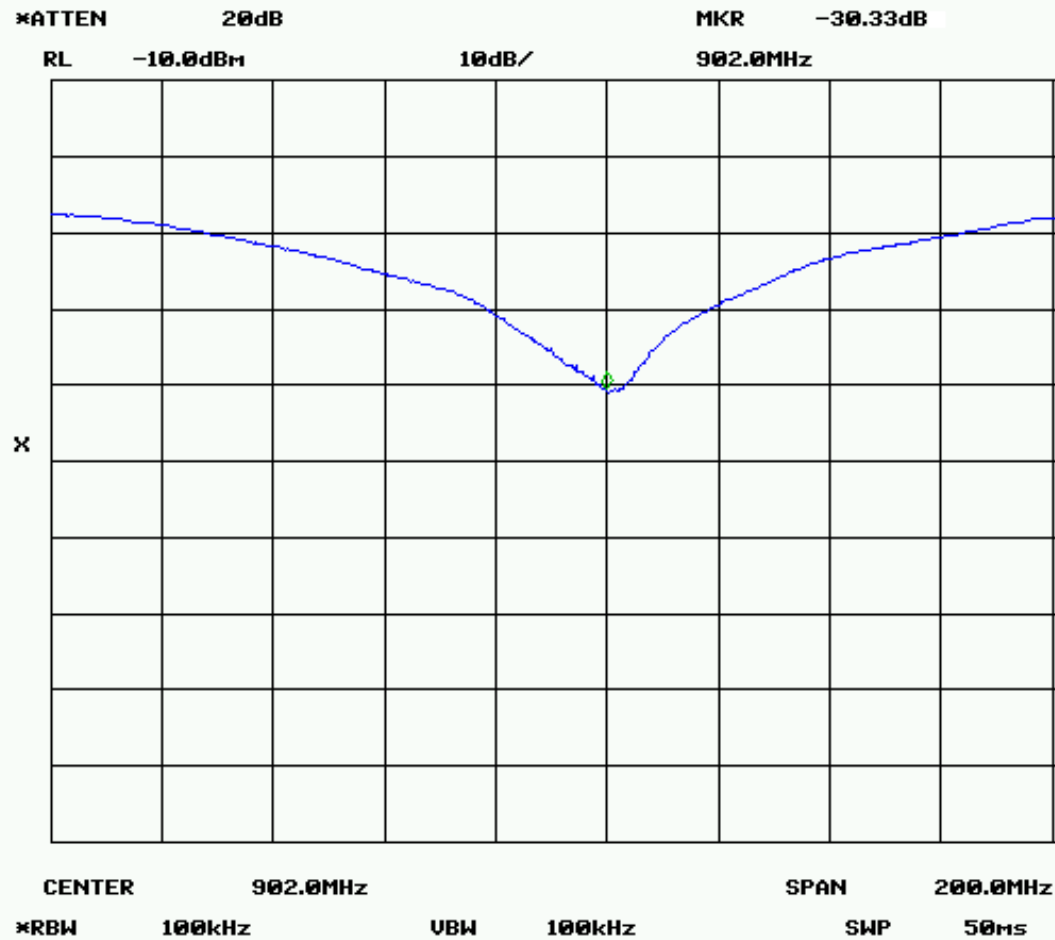
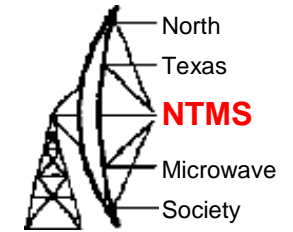

WW2R 3M Dish on 902 MHz

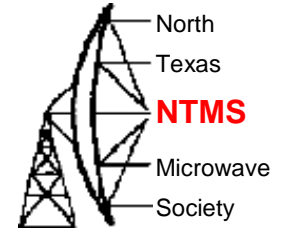

902 MHz Feed at WW2R

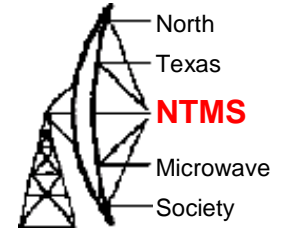

Waterproofing Feed at WW2R



Summary

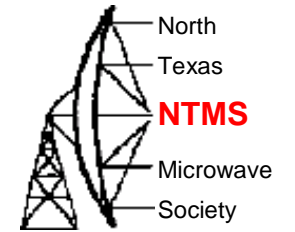

- Questions?
- Group buys?