

10 GHz Transverter From Surplus Parts

HAMCOM 2013

Plano, TX

Bob Gormley WA5YWC

Hamcom 2012 Presentation

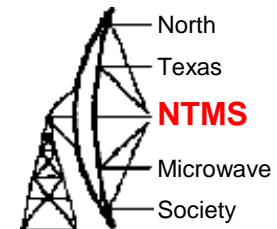

Basic Components

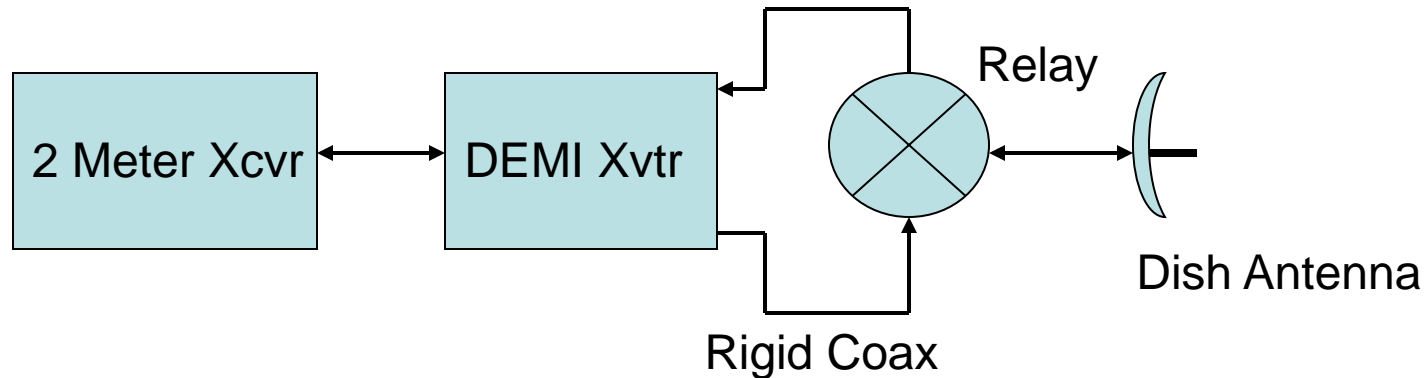

- **Down East Microwave 10 GHz Transverter Kit**
- **2 meter I/F transceiver**
- **Relay and rigid coax**
- **Dish or Horn antenna**

2 Meter Multimode I/F Radio



- FT-817
- FT-857
- IC-202
- FT-290
- IC-251
- TS-700A

- My choice is the ICOM IC-706. Affordable and readily available
- 10 Watts out on 2 meters, adjustable to 0.5 watts out
- Built-in keyer, Accessory jack for transceiver interface

DEMI Transverter Kit

Osc/multiplier

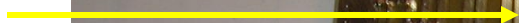

Pipe Cap Filters



DC Control Board

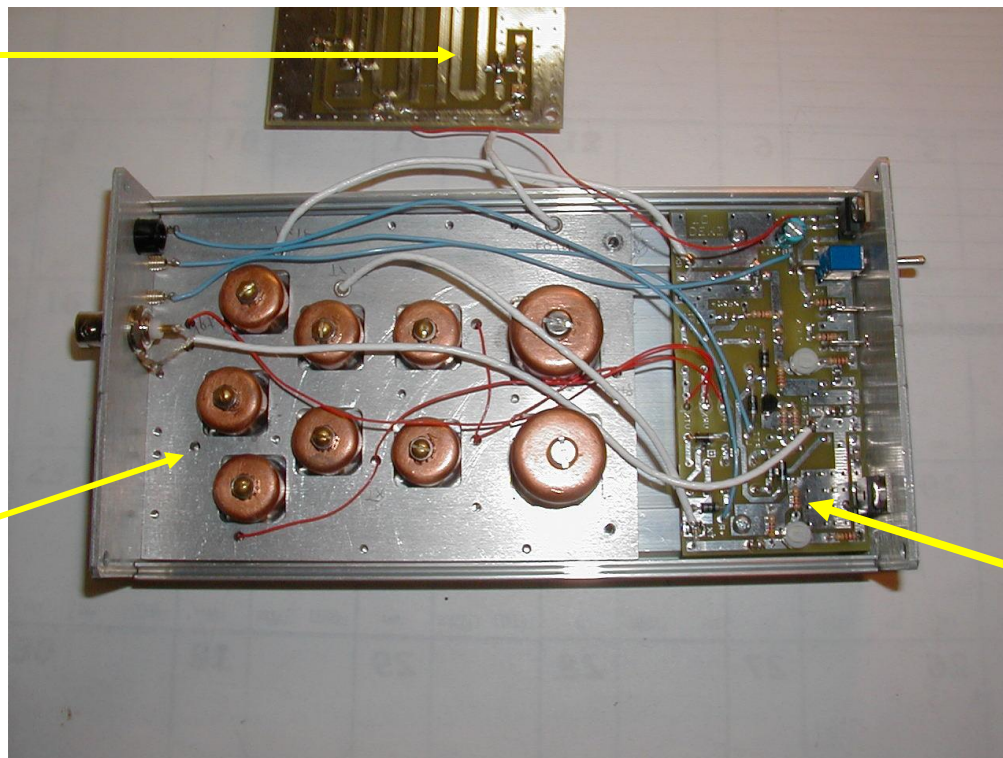

Top View

DEMI Transverter Kit

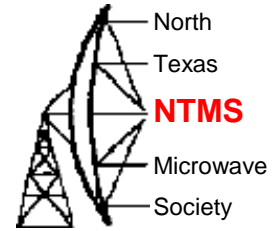

144 MHz in/out

10 GHz in

10 GHz out
(10 mW)

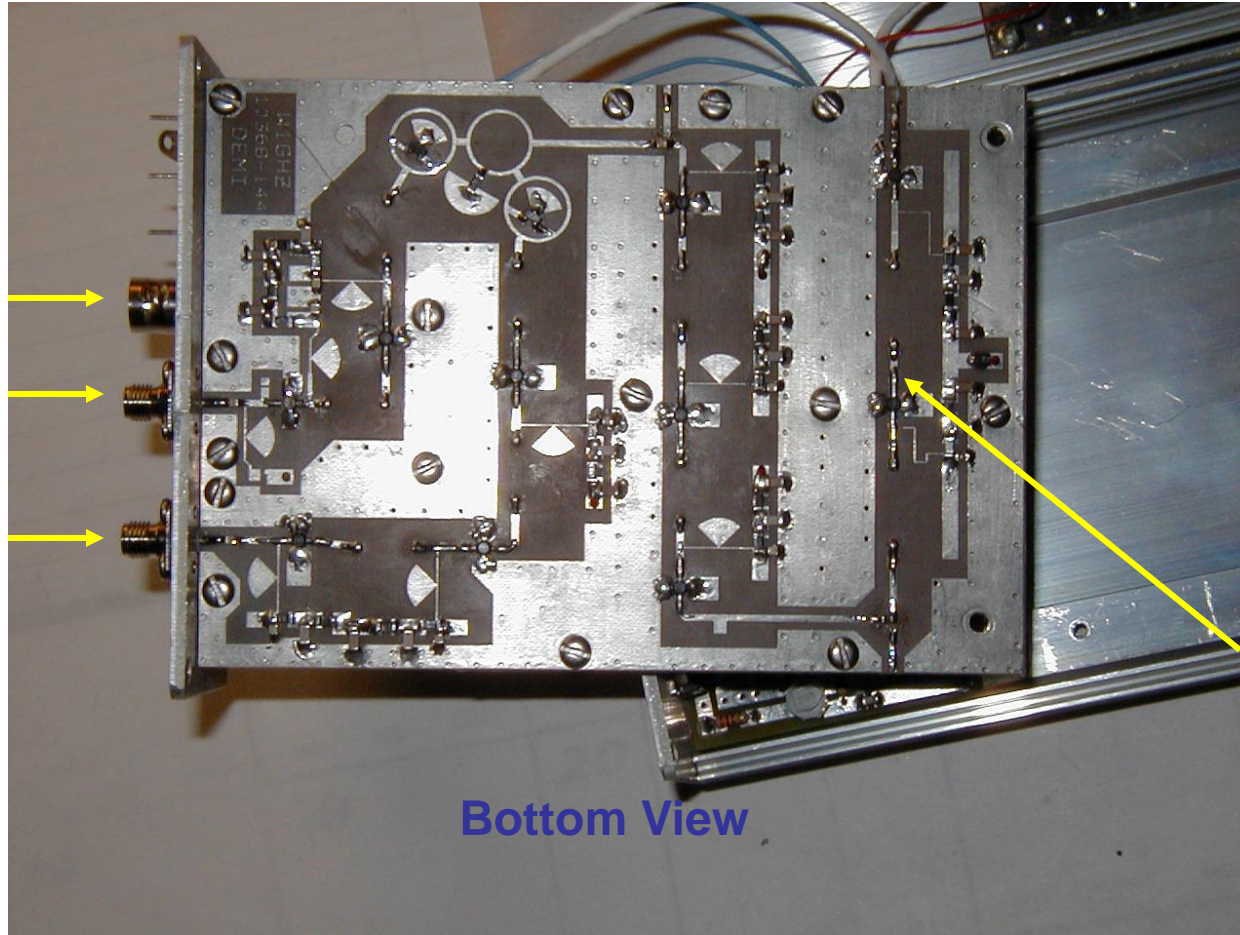

Bottom View

Surface mount construction

Basic Building Blocks for a 10GHz Transverter

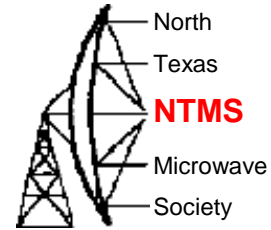

- Local Oscillator
- Frequency multiplier
- Power Divider
- Mixer
- Isolators
- Filter
- Low Noise Amplifier for Receive
- Power Amplifier for Transmit
- Transmit/Receive Relay
- Hardline Coax with connectors

Brick Oscillator

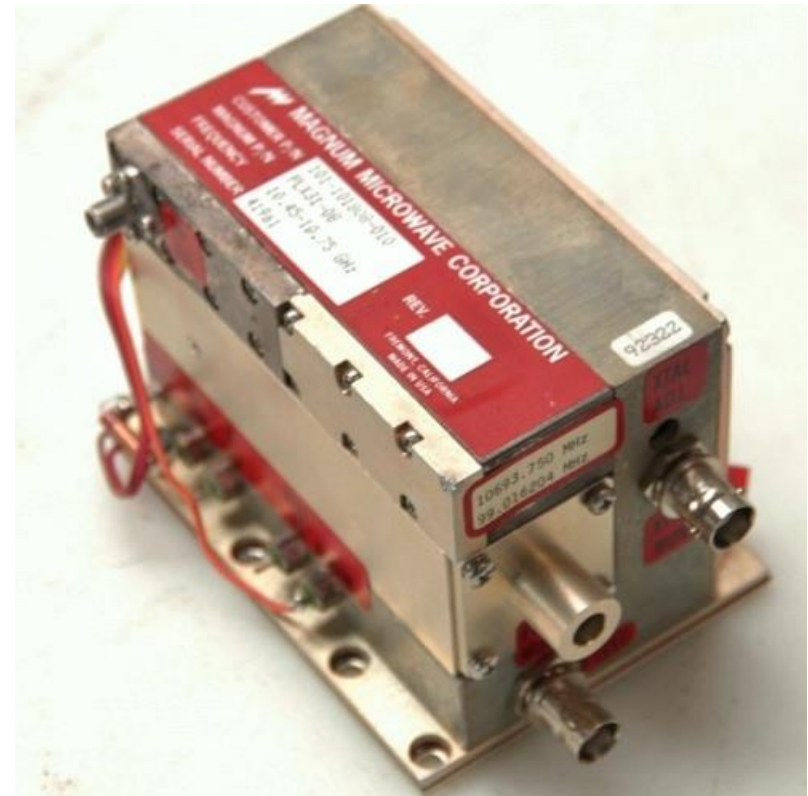

AD6IW μ Wave PLL LO

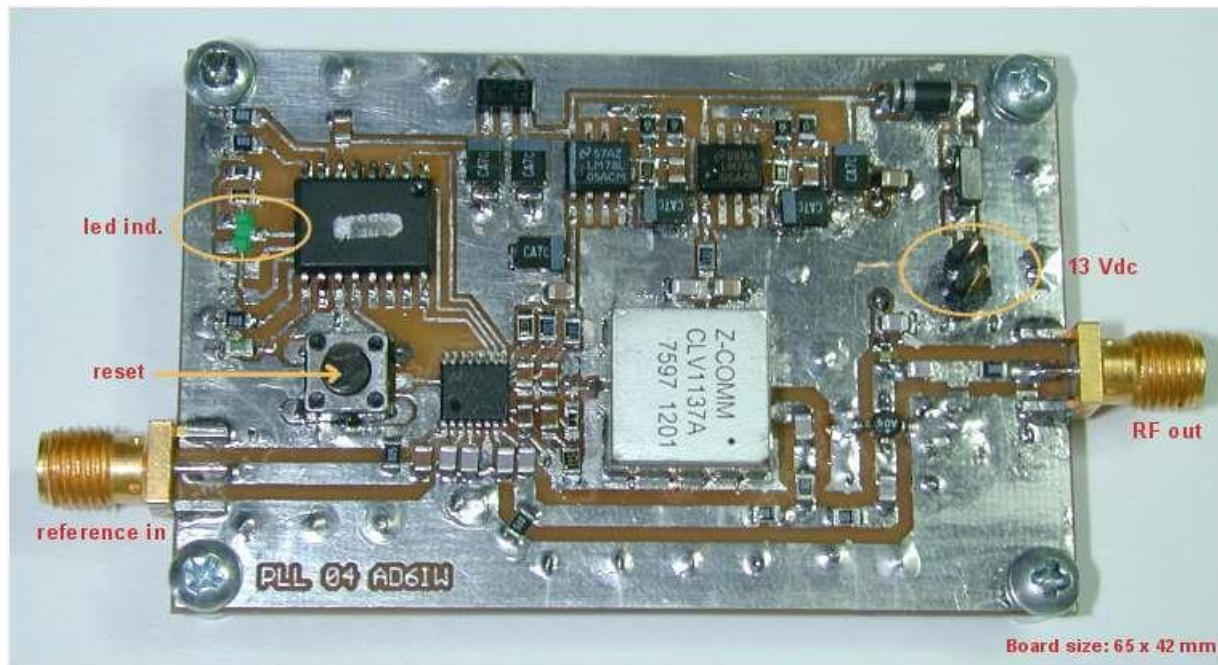

Available from Goran Popovic, AD6IW
ad6iw@ad6iw.com

ApoLO A32 Frequency Synthesizer By Steve Hicks, N5AC

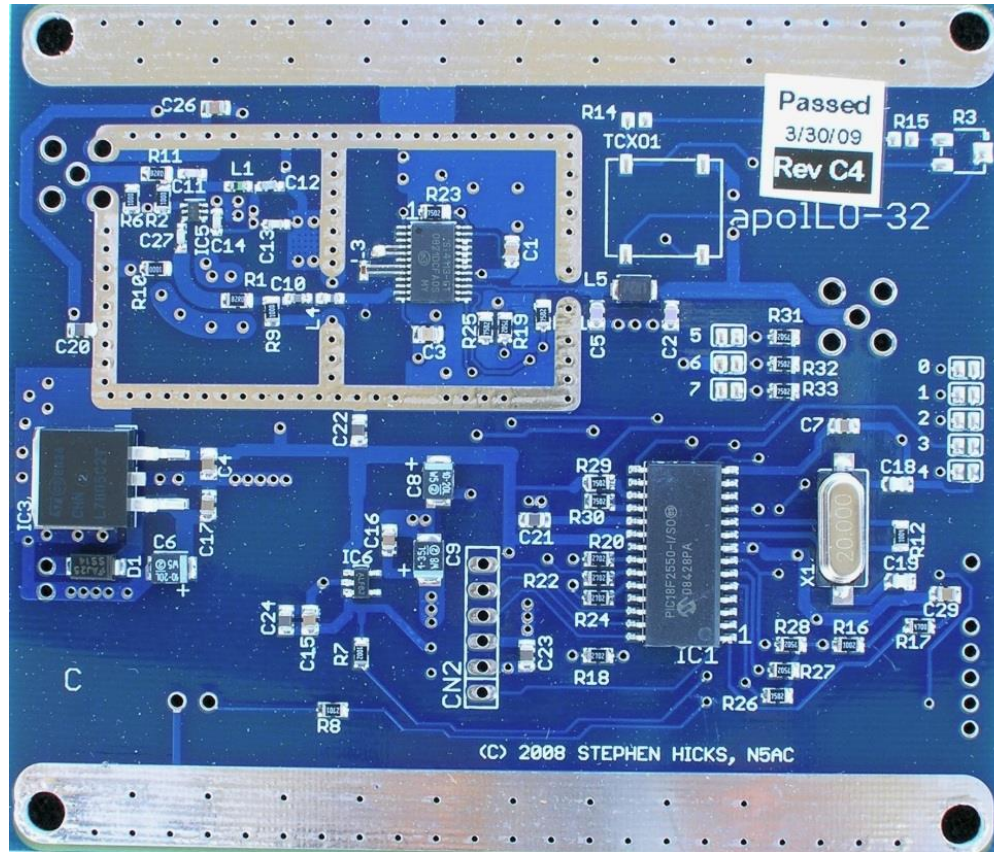
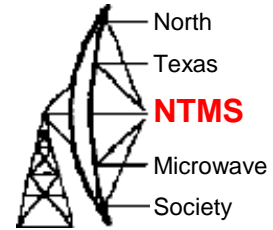

Available from Down East Microwave.

Frequency Multiplier

By
W1GHZ

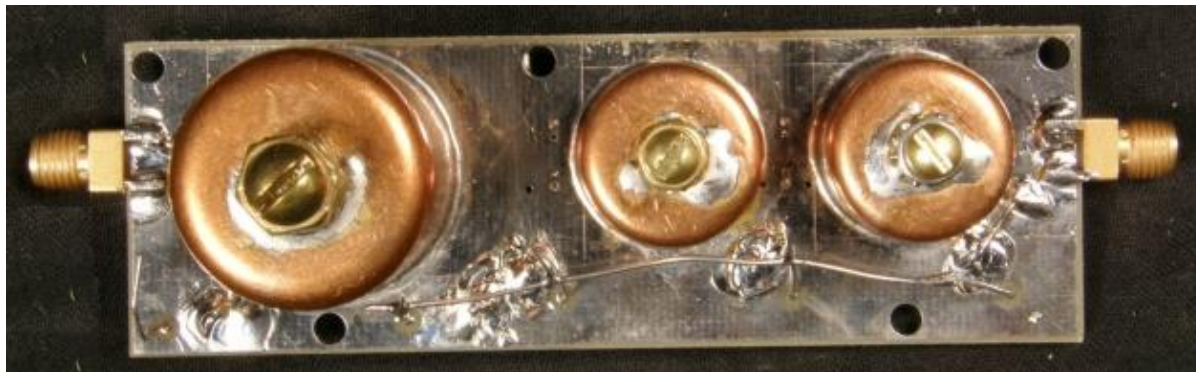

Personal Beacon for 10GHz by Paul Wade, W1GHZ
Contact Paul at w1ghz@arrl.net
www.w1ghz.org

Power Splitter

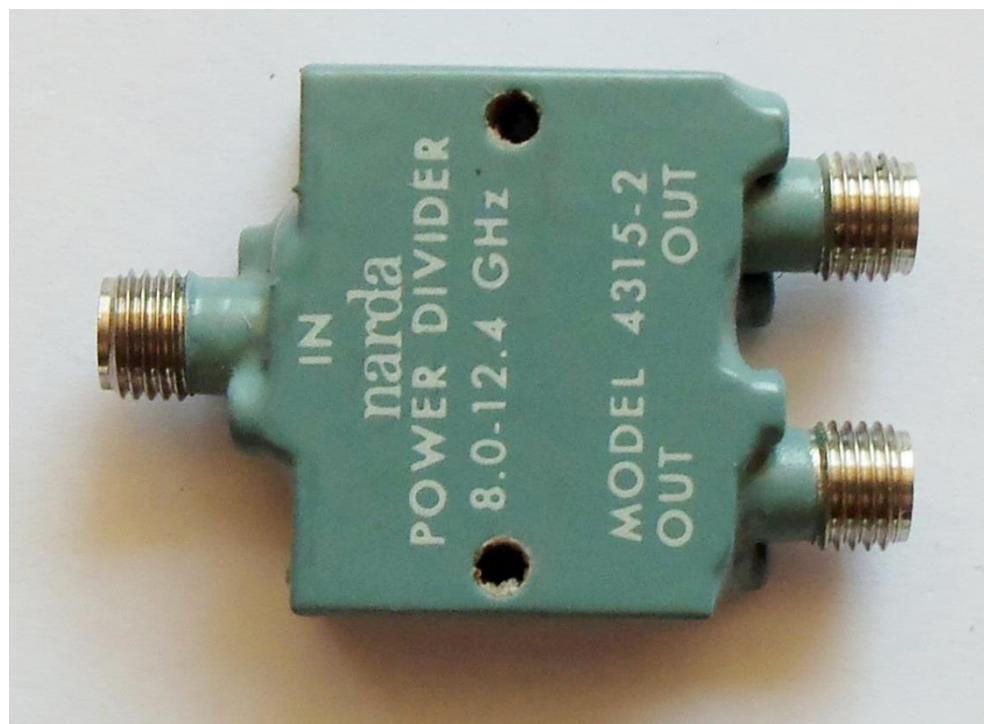

Microwave Mixer

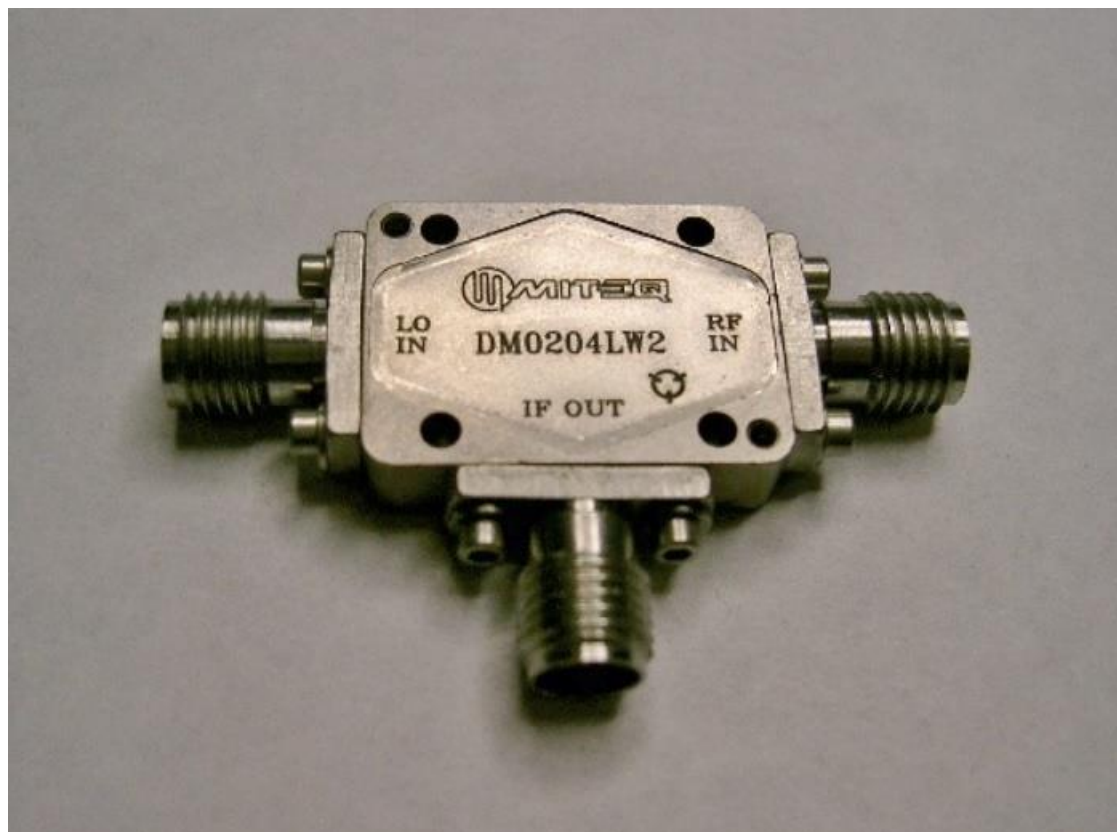

Microwave Isolator



Waveguide Filter

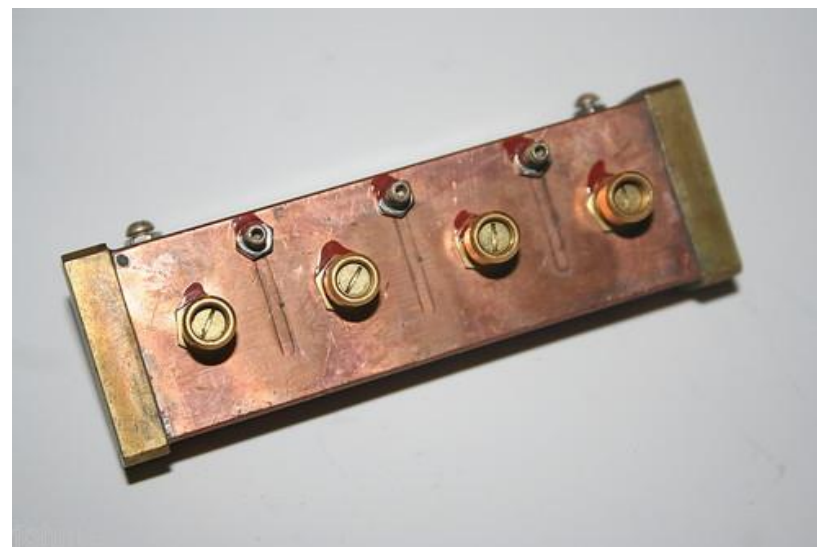

Low Noise Amplifier for RX

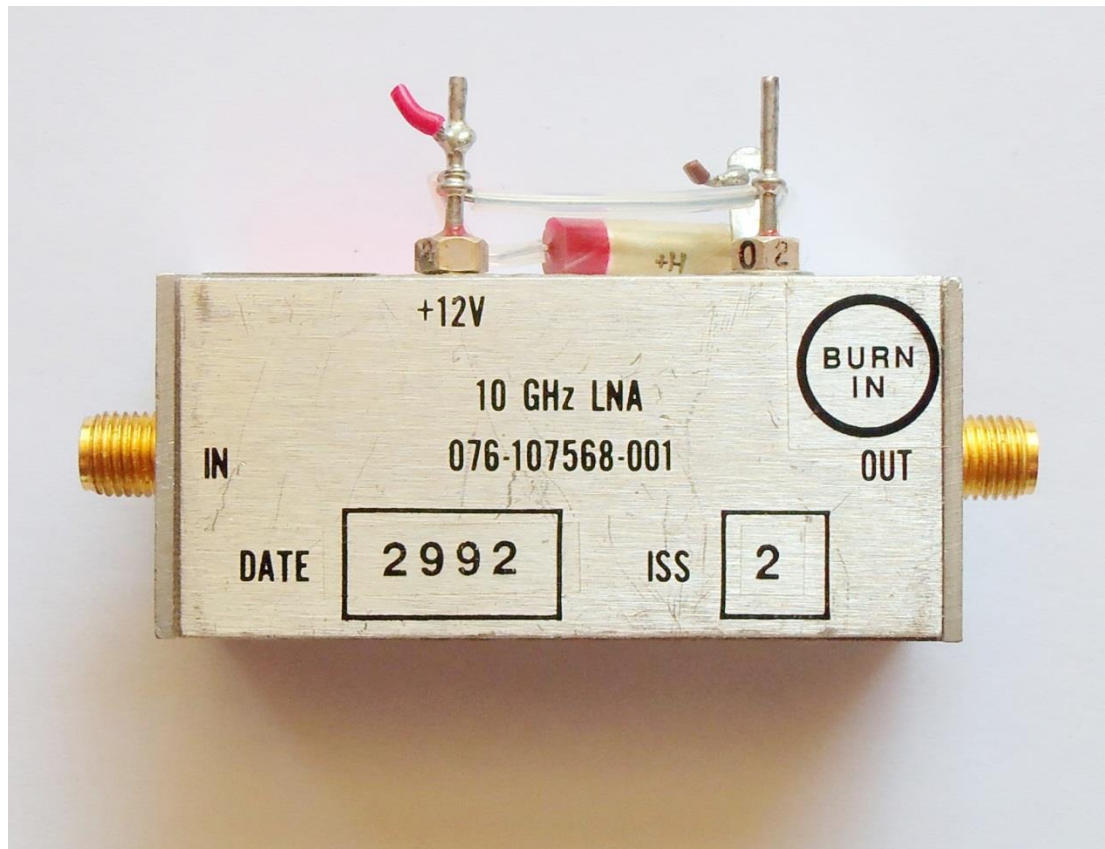

Power Amplifier for TX

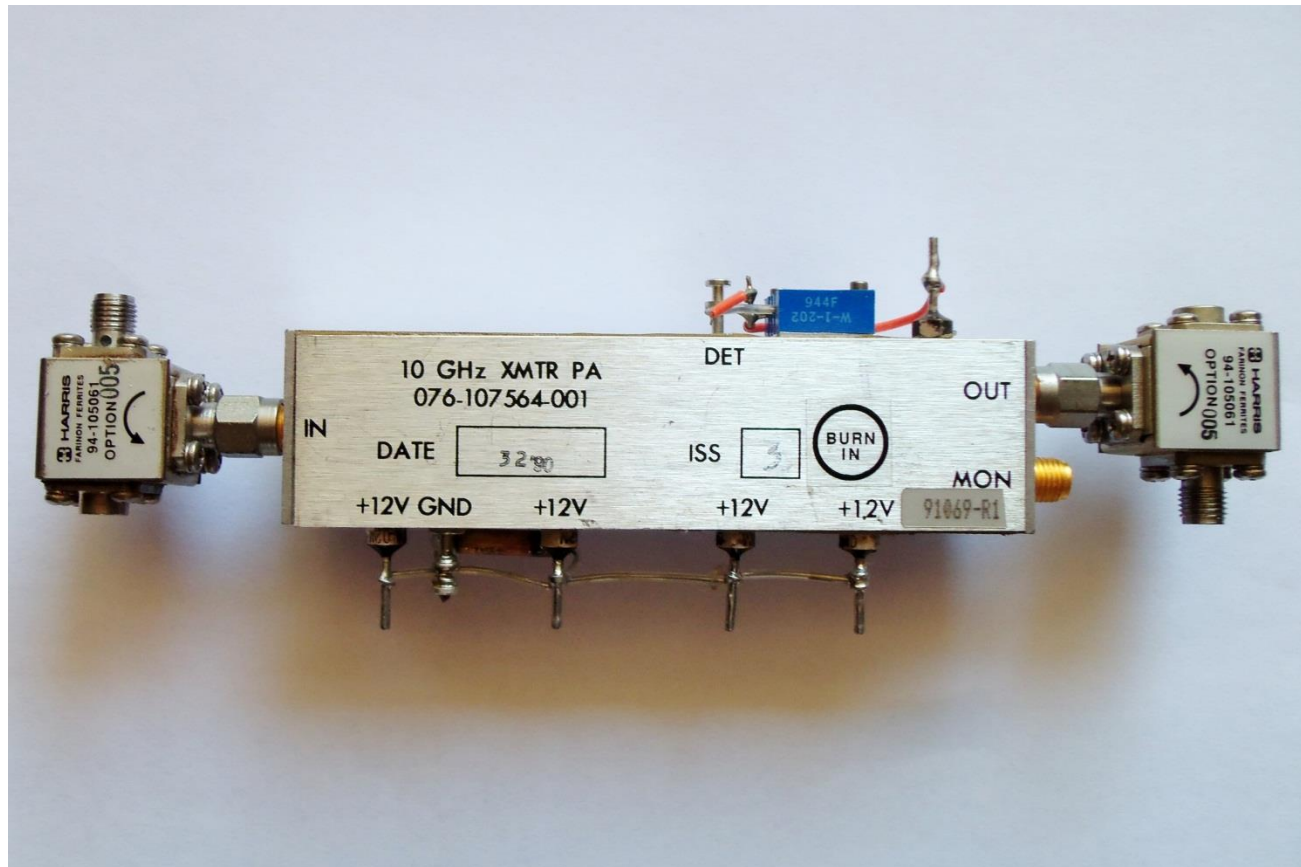

Relays



SPDT 28 VDC
0-18 GHz - SMA



Transfer Relay
0-18 GHz - SMA

Hardline Coax



10 GHz Transverter With Connectorize Parts

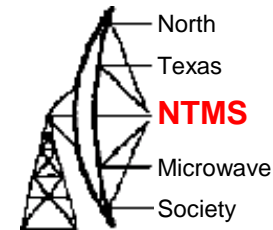

1136 MHz LO



X9 Multiplier

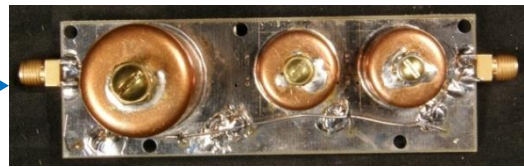

10224 MHz

Pwr Splitter

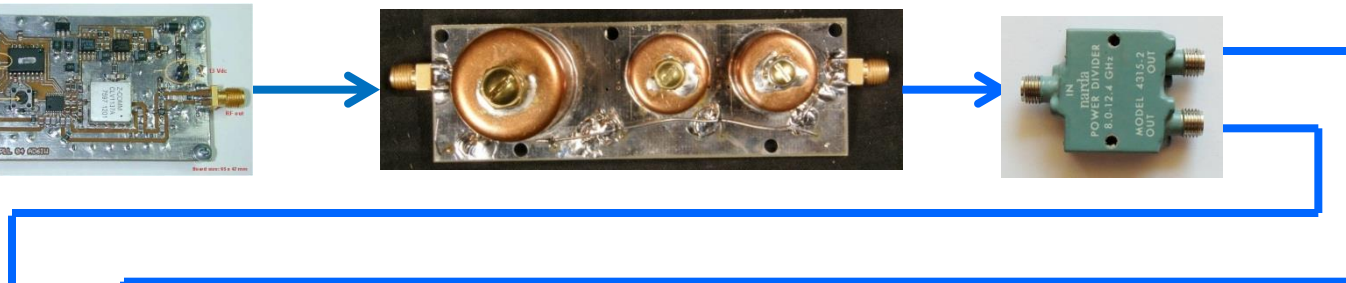

RX Mixer



WG Filter



A

Dish Ant



2M I/F



PA



TX Mixer



WG Filter

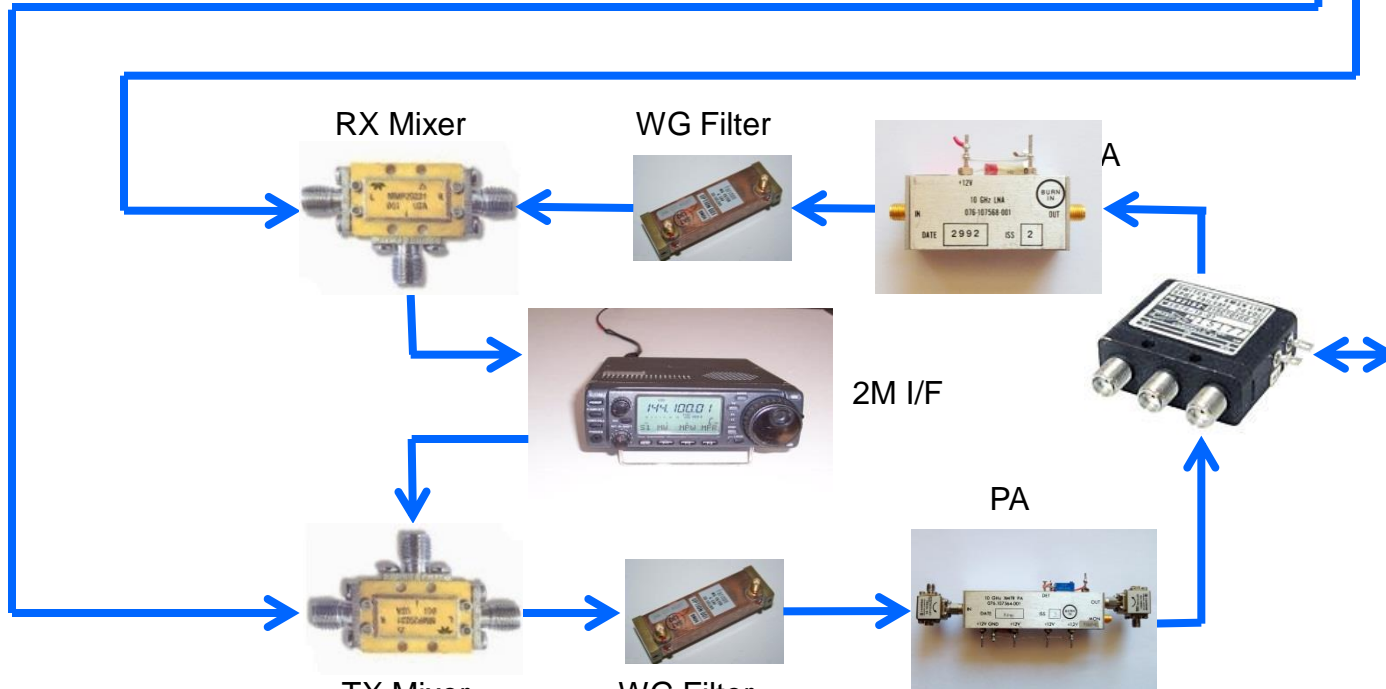

Revision 1

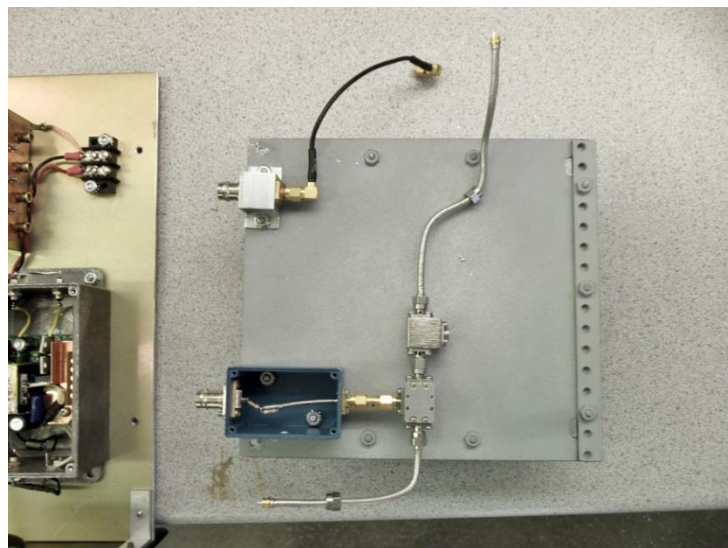
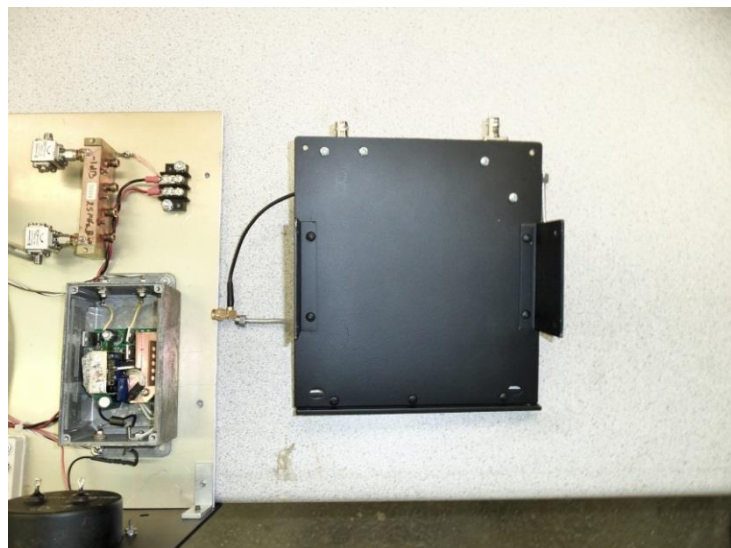
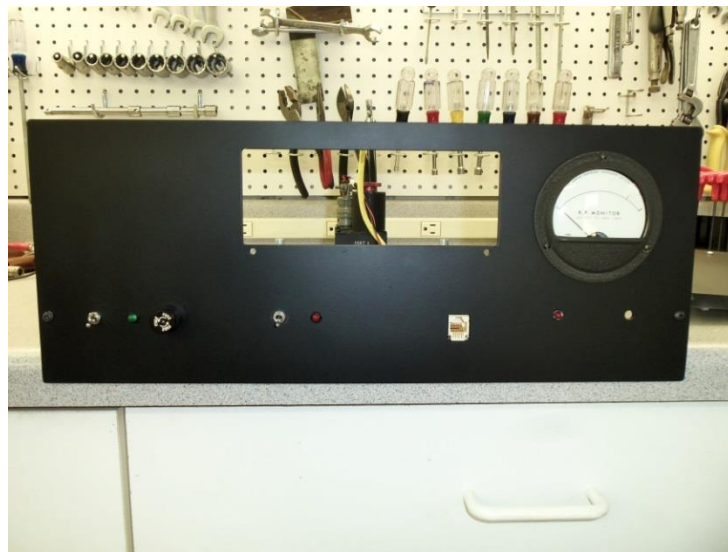
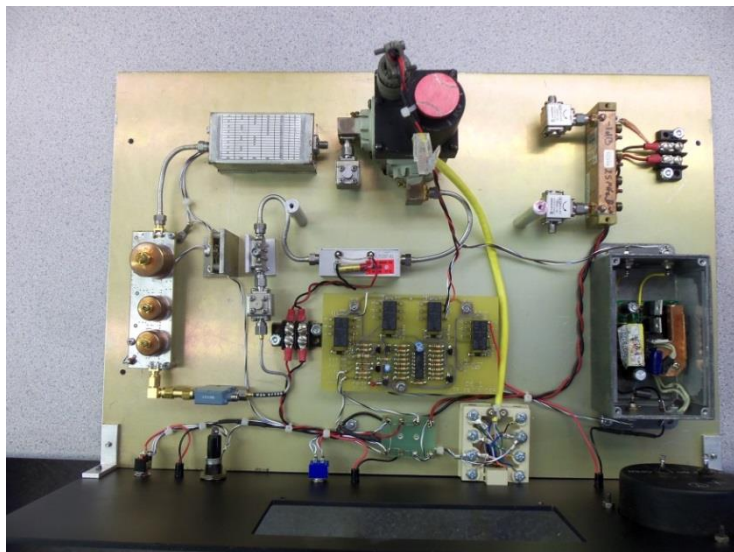
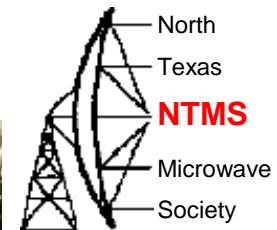



Back View

Top View



Revision 1 with TWTA

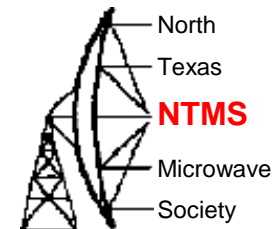

10 GHz and Above Contest

September 2012

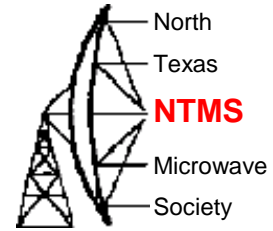

Revision 2

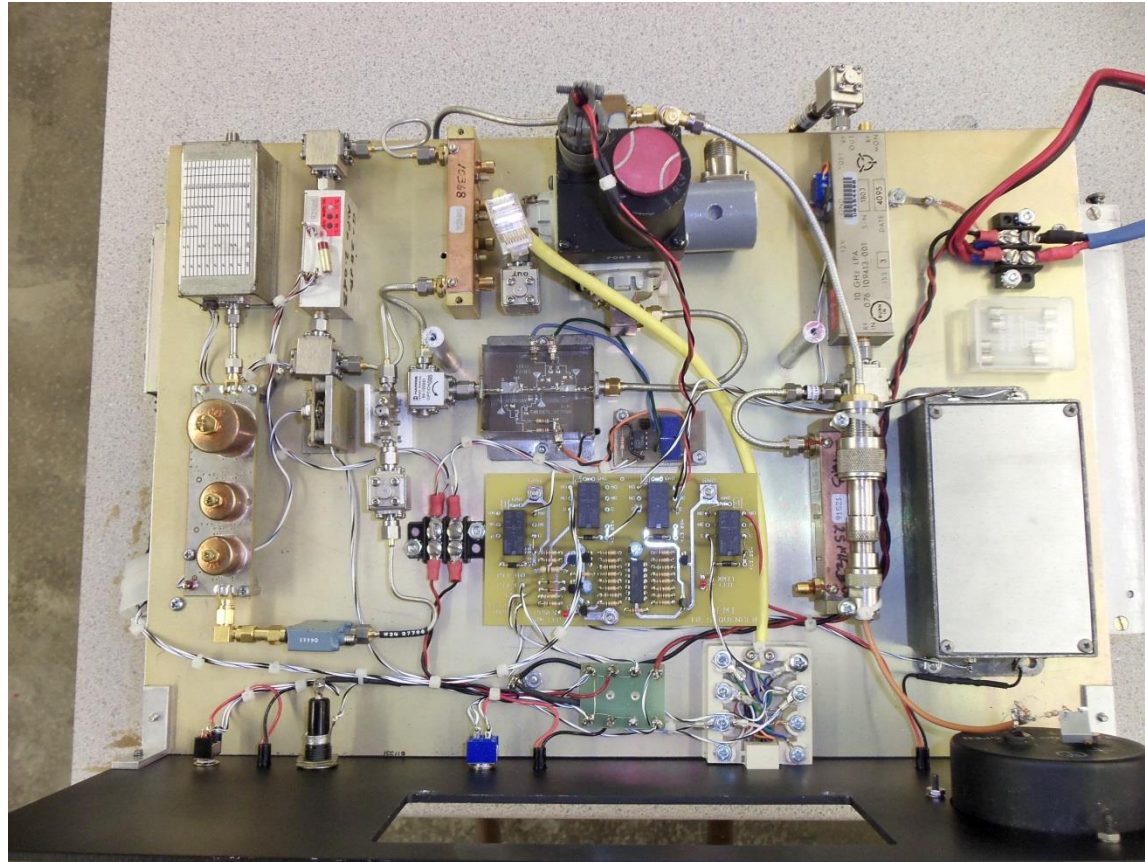

Added second stage pre-amp, filter, low power PA, power monitor circuit.

Revision 3: Integrated Dish and heavy duty tripod

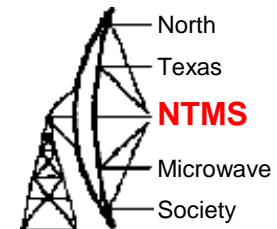

Monitoring 10 GHz beacon in Denton, TX from Plano, TX (22.9 miles)

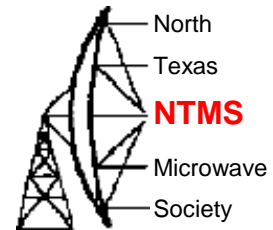

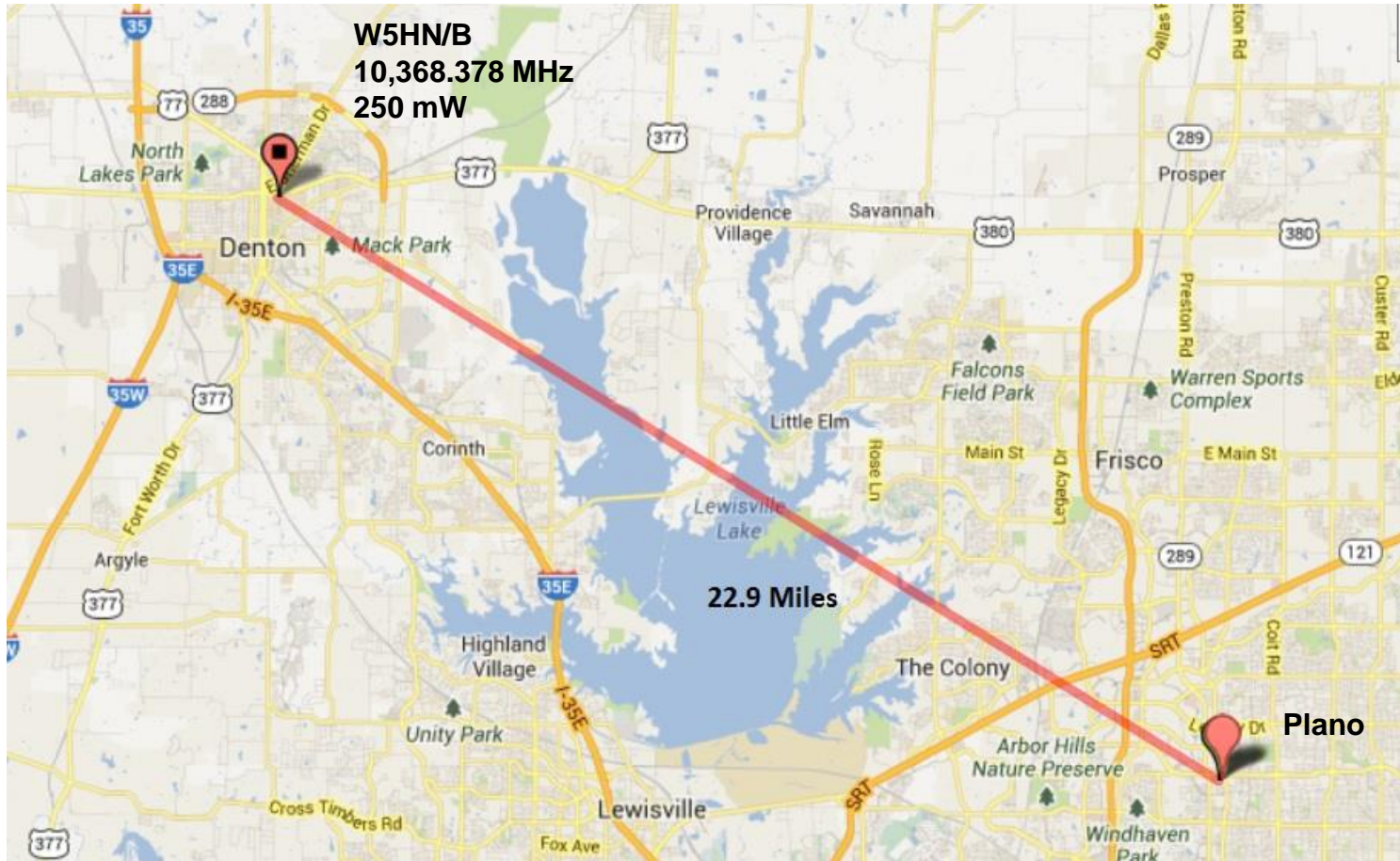
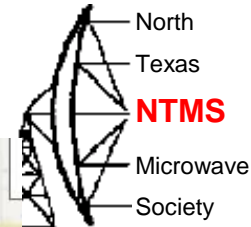

104_0426.MOV

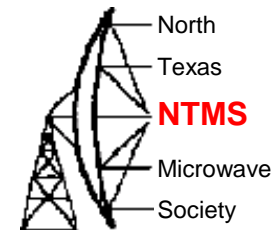

www.ntms.org