

Welcome to The North Texas Microwave Society June 14, 2025

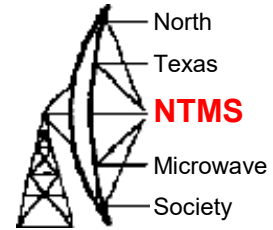

Beacon prototype platform

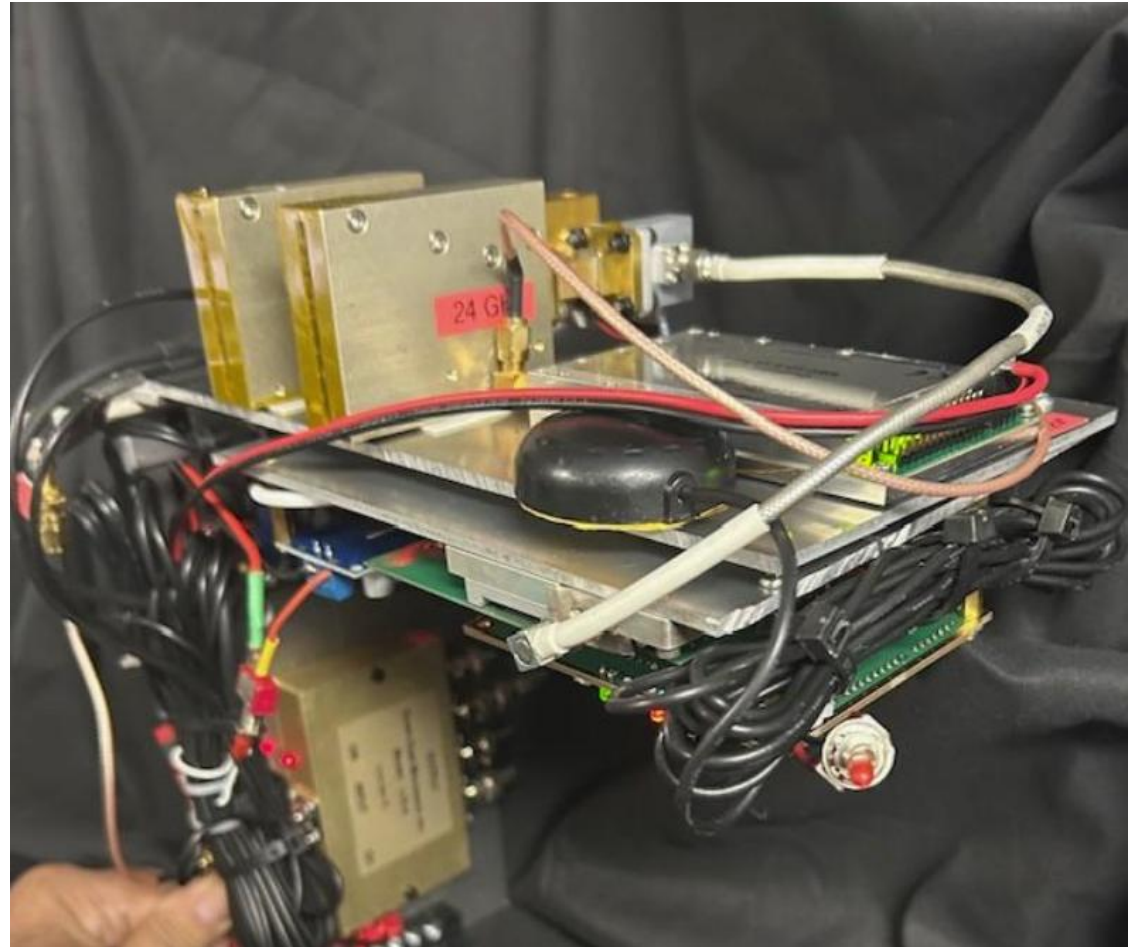
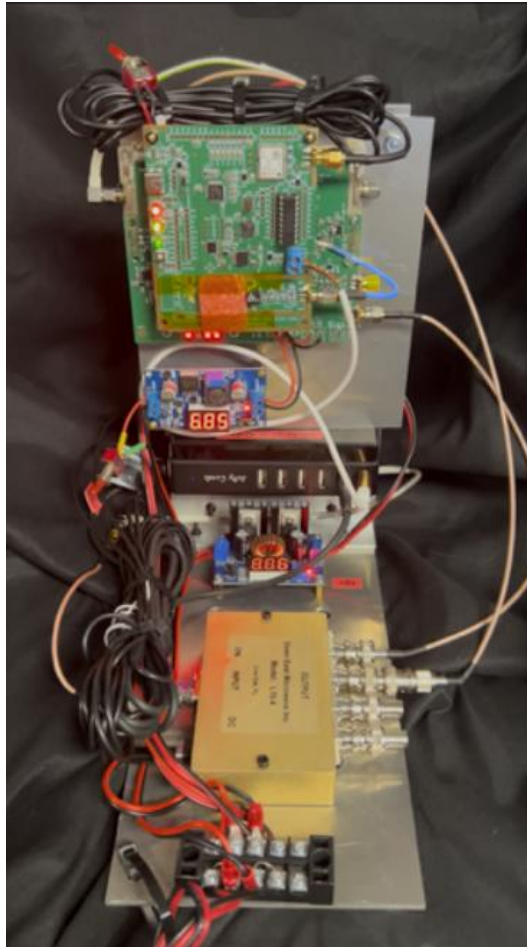
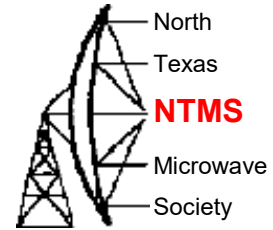

RFzero 144 MHz injection point on Wavelab control board

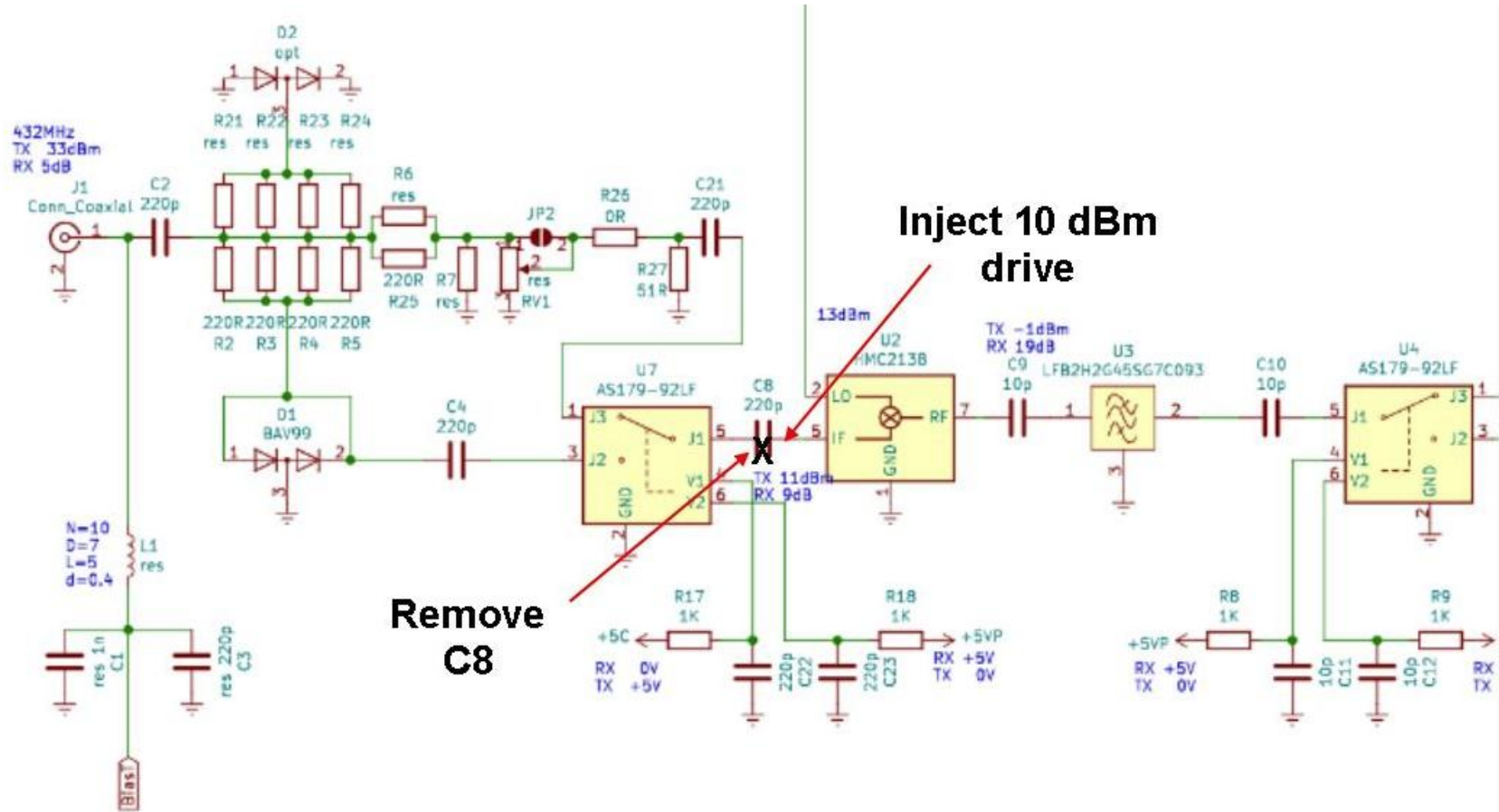

NTMS Agenda

March 8, 2025

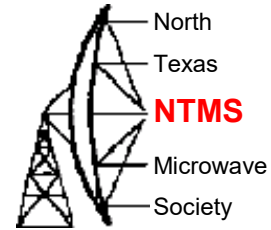

- 12:30 to 1:00– Setup & Bull Session
- 1:00 pm - Meeting Starts
- Technical Program
 - HP WR28 to WR42 ridged transition modified to work at 24 GHz - AI W5LUA
 - New rover 24 GHz wavelab units - Jim KM5PO
 - Texas A&M Chapter of the IEEE Microwave Theory and Technology Society (MTT-S TAMU) - MTT Staff
 - Working microwave DX in recent tropo opening across the Gulf- AI W5LUA with additional info from WB4OMG, W4ERP & K4VJ
- Show & Tell by members
- Other items & Business Meeting

MTT-S TAMU sponsorship

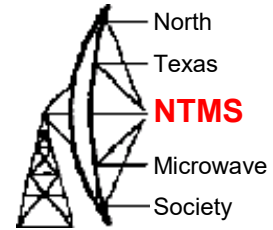

- Mats KD5FZX has donated a Systron Donner (18 GHz) Frequency Counter to MTT-S TAMU. Internal/External 10 MHz ref.



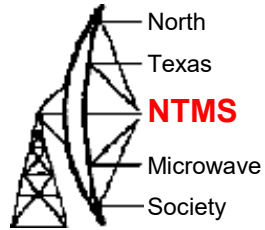

Phishing / scam emails

- Be alert to bad guy schemes
- Watch for
 - Out of character requests – NTMS officers will not solicit through text or email
 - Return email address or URL to click is suspicious
 - Sense of urgency
- Actions to take
 - Contact the person directly
 - Report the email as spam

Phishing / scam emails

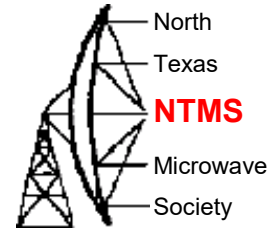

From: Jim McMasters, KM5PO <qwerty3321@virginmedia.com>
Sent: Friday, June 13, 2025 08:09
To: wa5tku@atchisonlocal.com <wa5tku@atchisonlocal.com>
Subject: Events/Operating Expenses (Networking Activities Website Hosting and Program Services)

Hi,

Could you please send over the Balance Sheet and confirm if we have ACH/Zelle payment capabilities set up with our account? Also, please let me know the process for making payments on outstanding expenses.

Thanks,
Jim McMasters

June 2025

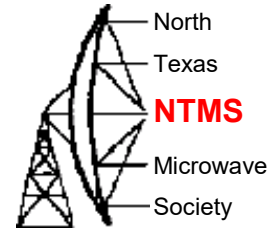

- 7th (Saturday) NTMS MAD – Microwave Activity Day
- 14th NTMS June Zoom meeting
- 14th – 16th ARRL June VHF contest
- 28th – 29th ARRL Field Day

July 2025

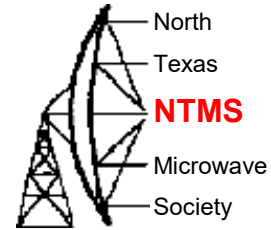

- 5th (Saturday) NTMS MAD – Microwave Activity Day
 - Note, July and August MAD are the last 2 testing days before the contest
- 12th NTMS July Zoom meeting
 - Whole house UPS & homebrew 15kwh LFP battery - Doug Knabe KN5DK
- 24th to 27th – 57th annual meeting of Central States VHF Society
 - Lincoln, Nebraska

August 2025

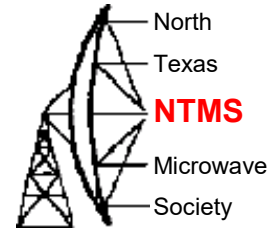

- 2nd (Saturday) NTMS MAD – Microwave Activity Day
 - Note, last MAD testing day before the contest
- 9th NTMS August Zoom meeting
 - Your presentation goes here
- 12th Perseids meteor shower peak
- 16th to 18th – ARRL 10 GHz and Up contest (part 1)

Perpetual

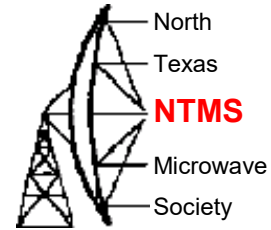

- **NTMS 2 meter net**
Every Sunday, 8:00 pm CST, 144.260 MHz, called by Ross K5ZSJ
- **The 6 meter Hootowl net**
Every Saturday, Midnight, 50.125, called by Al W5RLG
- **NTMS Lunch**
Every Tuesday, 11:30 am CST, Texas Smokehouse BBQ, Richardson TX (May change around holidays)
- **144 MHz Activity Night.**
Every Monday 7:00-11:00 pm local
- **222 MHz Activity Night.**
Every Tuesday 7:00-11:00 pm local
- **432 MHz Activity Night.**
Every Wednesday 7:00-11:00 pm local
- **Midwest M.A.D. and NTMS M.A.D**
First Saturday of every month.

Business Meeting

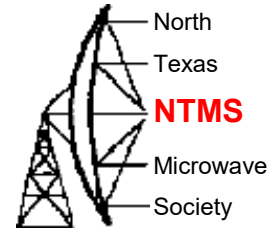

- Old Business
- New Business
- Any other topics to be discussed?

NTMS Budget & Dues

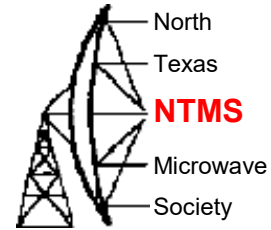

- Zoom Meeting \$160/yr
- Website Blue Host \$86/yr
- ARRL Liability Insurance \$200/yr
- PO Box \$146/yr
- 501c3 non profit filing with TX \$25/yr
- Total \$617 / \$20 dues > 31 members min
- Does not include meeting room space and ARRL Spectrum Defense Fund donations
- Please support the NTMS with your \$20 annual dues. Information on paying dues at www.ntms.org (see Membership link on left side of home page)

Adjourn?

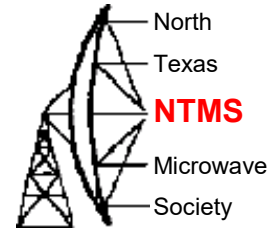

- Motion to adjourn?